

Chapter 11

Shipboard Fire Fighting

Fire aboard ship is a terrifying experience. It is a situation where the crew must work together as a team to survive. To do this you must know the type of fire you are fighting, select the right extinguishing agent, and know how to use the fire fighting equipment aboard ship to put out the fire. Once you understand what fire is, then you can take the proper actions for putting the fire out. This chapter covers the following:

- Definition of fire.
- Classes of fire.
- Effective agents to control and extinguish each class of fire.
- Types of fire fighting equipment.
- Different types of self-contained breathing apparatus.

CHEMISTRY OF FIRE

11-1. Oxidation is a chemical process in which a substance combines with oxygen. During this process, energy is given off usually in the form of heat. Rusting iron and rotting wood are common examples of slow oxidation. Fire, or combustion, is rapid oxidation; the burning substance combines with oxygen at a very high rate. Energy is given off in the form of heat and light. Because this energy production is so rapid, we can feel the heat and see the light as flames.

THE START OF A FIRE

11-2. All matter exists in one of three states: solid, liquid, or gas (vapor). The atoms or molecules of a solid are packed closely together, and those of a liquid are packed loosely. The molecules of a vapor are not packed together at all; they are free to move about. In order for a substance to oxidize, its molecules must be pretty well surrounded by oxygen molecules. The molecules of solids and liquids are packed too tight to be surrounded by oxygen molecules. Therefore, only vapors can burn.

11-3. When a solid or liquid is heated, its molecules move about rapidly. If enough heat is applied, some molecules break away from the surface to form a vapor just above the surface. This vapor can now mix with oxygen. If there is enough heat to raise the vapor to its ignition temperature, and if there is enough oxygen present, the vapor will oxidize rapidly--it will start to burn.

BURNING

11-4. What we call burning is the rapid oxidation of millions of vapor molecules. The molecules oxidize by breaking apart into individual atoms and recombining with oxygen into new molecules. It is during the breaking-recombining process that energy is released as heat and light.

11-5. The heat that is released is radiant heat, which is pure energy. It is the same sort of energy that the sun radiates and that we feel as heat. It radiates, or travels, in all directions. Therefore, part of it moves back to the seat of the fire, to the "burning" solid or liquid (the fuel).

11-6. The heat that radiates back to the fuel is called radiation feedback (Figure 11-1). Part of this heat releases more vapor and part of it raises the vapor to the ignition temperature. At the same time, air is drawn into the area where the flames and vapor meet. The result is that there is an increase in flames as the newly formed vapor begins to burn.

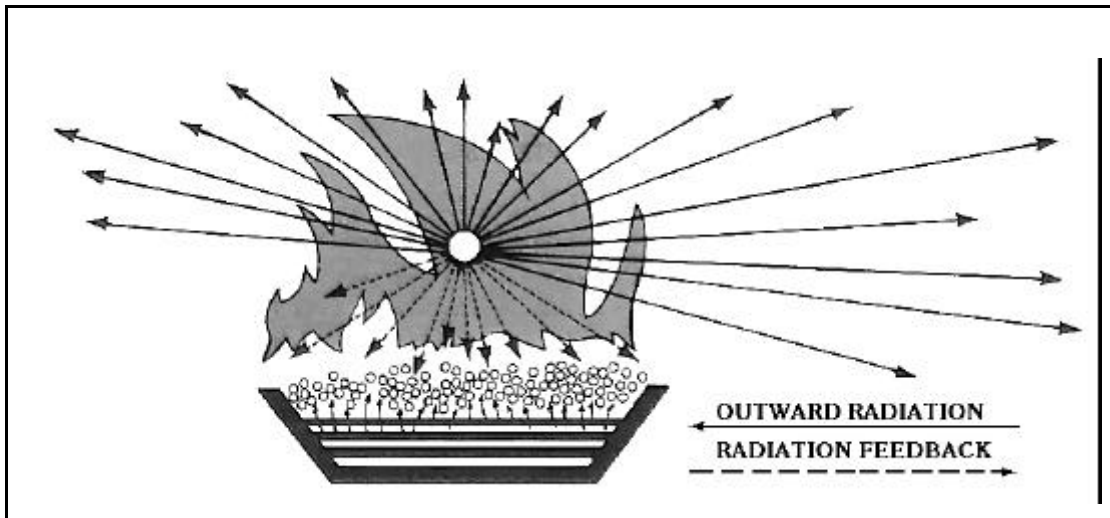

Figure 11-1. Radiation Feedback

THE FIRE TRIANGLE

11-7. The following are the three things that are required for combustion:

- Fuel (to vaporize and burn).
- Oxygen (to combine with fuel vapor).
- Heat (to raise the temperature of the fuel vapor to its ignition temperature).

The fire triangle illustrates these requirements (Figure 11-2). It also illustrates two important facts in preventing and extinguishing fires.

- If any side of the fire triangle is missing, a fire cannot start.
- If any side of the fire triangle is removed, the fire will go out.

A fire can be extinguished by destroying the fire triangle. If fuel, oxygen, or heat is removed, the fire will die out. If the chain reaction is broken, the resulting reduction in vapor and heat production will put out the fire. Additional cooling with water may be necessary where smoldering or reflash is possible.

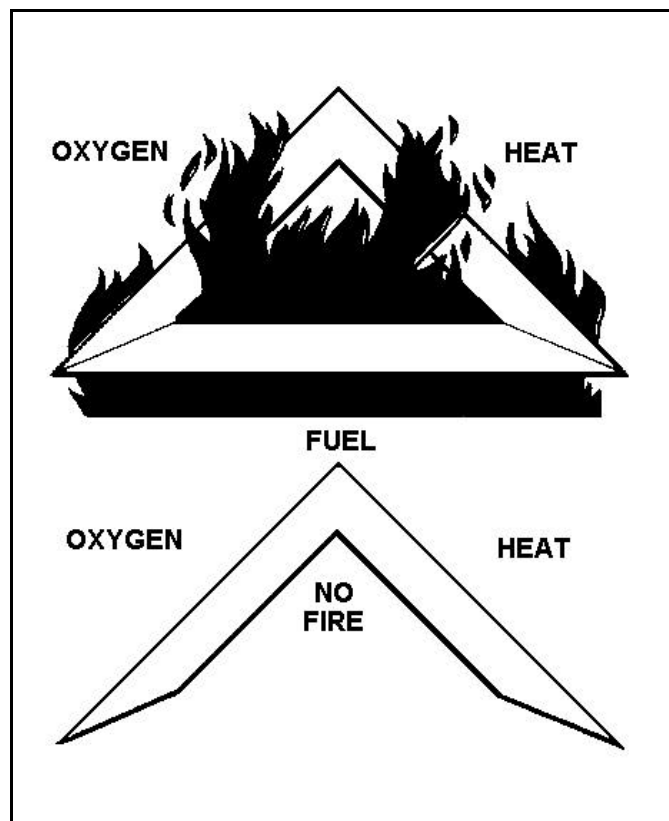

Figure 11-2. Fire Triangle With One Side Missing

FUELS AND FUEL CHARACTERISTICS

11-8. Fuels and fuel characteristics are important for the mariner to know so that they can identify what fire fighting agent should be used in fighting a fuel fire.

Solid Fuels

11-9. The most obvious solid fuels are wood, paper, and cloth. These can be found aboard ship as cordage, canvas, dunnage, furniture, plywood, wiping rags, and mattresses. The paint on bulkheads is also a solid fuel. Vessels may carry a wide variety of solid fuels as cargo (from baled materials and goods in cartons to loose materials, such as grain). Metals such as magnesium, sodium, and titanium are also solid fuels that may be carried as cargo.

Ignition Temperature

11-10. The ignition temperature of a substance (solid, liquid, or gas) is the lowest temperature at which sustained combustion will occur without the application of a spark or flame. Ignition temperatures vary among substances. For a given substance, the ignition temperature also varies with bulk, surface area, and other factors. The ignition temperatures of common combustible materials is between 149°C (300°F) and 538°C (1,000°F).

Liquid Fuels

11-11. The flammable liquids most commonly found aboard ship are bunker fuel, lubricating oil, diesel oil, kerosene, and oil-base paints and their solvents. Cargo may also include flammable liquids and liquified flammable gases.

Vaporization

11-12. Flammable liquids release vapor in much the same way as solid fuels. The rate of vapor release is greater for liquids than for solids, since liquids have less closely packed molecules. Liquids can also release vapor over a wide temperature range. Gasoline starts to give off vapor at -43°C (-45°F). This makes gasoline a continuous fire hazard; it produces flammable vapor at normal temperatures. Heating increases the rate of vapor release.

11-13. Heavier flammable liquids such as bunker oil and lubricating oil must be heated to release sufficient vapor for combustion. Lubricating oils can ignite at 204°C (400°F). A fire reaches this temperature rapidly, so that oils directly exposed to a fire will soon become involved. Once a light or heavy flammable liquid is burning, radiation feedback and the chain reaction quickly increases flame production.

11-14. The vapor produced by a flammable liquid is heavier than air. This makes the vapor very dangerous because it will seek low places, dissipate slowly, and travel to a distant source of ignition. For example, vapor escaping from a container can travel along a deck and down deck openings until it contacts a source of ignition (such as a spark from an electric motor). If the vapor is properly mixed with air, it will ignite and carry fire back to the leaky container. The result can be a severe explosion and fire.

Flash Point

11-15. The flash point of a liquid fuel is the temperature at which it gives off sufficient vapor to form an ignitable mixture near its surface. Sustained combustion takes place at a slightly higher temperature, referred to as the fire point of the liquid. The flash points and fire points (temperatures) of liquids are determined in controlled tests.

Gaseous Fuels

11-16. There are both natural and manufactured flammable gases. Those that may be found on board a vessel include acetylene, propane, and butanes.

Burning

11-17. Gaseous fuels are already in the required vapor state. Only the correct intermix with oxygen and sufficient heat are needed for ignition. Gases, like flammable liquids, always produce a visible flame; they do not smolder.

Explosive Range (Flammable Range)

11-18. A flammable gas or the flammable vapor of a liquid must mix with air in the proper proportion to make an ignitable mixture. The smallest percentage of a gas (or vapor) that will make an ignitable air-vapor mixture is called the lower explosive limit of the gas (or vapor). If there is less gas in the mixture, it is too lean to burn. The greatest percentage of a gas (or vapor) in an ignitable air-vapor mixture is called its upper explosive limit. If a mixture contains more gas than the UEL, it is too rich to burn. The range of percentages between the lower and upper explosive limits is called the explosive range of the gas or vapor.

OXYGEN

11-19. The oxygen side of the fire triangle refers to the oxygen content of the surrounding air. Ordinarily, a minimum concentration of 16 percent oxygen in the air is needed to support flaming combustion. However, smoldering combustion can take place in about 3 percent oxygen. Air normally contains about 21 percent oxygen, 78 percent nitrogen, and 1 percent other gases, principally argon.

HEAT

11-20. Heat is the third side of the fire triangle. When sufficient heat, fuel, and oxygen are available, the triangle is complete and fire can exist. Heat of ignition initiates the chemical reaction that is called combustion. It can come from the flame of a match, sparks caused by ferrous metals striking together, heat generated by friction, lightning, an oxyacetylene torch cutting or welding metal, an electric short circuit, an electric arc between conductors, or the overheating of an electric conductor or motor.

CLASSES OF FIRE

11-21. There are four types or classes of fires (labeled A through D) according to their fuels. However, some fuels are found in combinations, and electrical fires always involve some solid fuel. Therefore, for fire fighting purposes, there are actually six classes:

- Class A Fires (common flammable solid fuel).
- Class B Fires (flammable liquid or gaseous fuel).
- Combined Class A and Class B fires (solid fuel combined with liquid or gaseous fuel).
- Combined Class A and Class C fires (solid fuel combined with electrical equipment).
- Combined Class B and Class C fires (liquid or gaseous fuel combined with electrical equipment).
- Class D fires (combustible-metal fuel).

This list includes every known type of fire. Note that the environment of a fire, that is, where it occurs, does not affect its classification. For example, Class B fires are Class B fires whether they occur in an engine room or on a pier.

11-22. The main purpose of this classification scheme is to help crew members pick the best extinguishing agent. The choice of an extinguishing agent depends on the class of fire, the hazards involved, and the agents available. It is not enough to know that water is best for putting out a class A fire because it cools, or that a dry chemical works well in knocking down the flames of a burning liquid. The extinguishing agent must be applied properly and sound fire fighting techniques must be used.

EXTINGUISHING AGENTS

11-23. An extinguishing agent is a substance that will put out a fire. Every extinguishing agent operates by attacking one or more sides of the fire triangle.

- **Cooling.** Reduces the temperature of the fuel below its ignition temperature. This is a direct attack on the heat side of the fire triangle (see Figure 11-3).
- **Smothering.** Separates the fuel from the oxygen. This can be considered as an attack on the edge of the fire triangle where the fuel and oxygen sides meet (see Figure 11-4).
- **Oxygen dilution.** Reduces the amount of available oxygen below that needed to sustain combustion. This is an attack on the oxygen side of the triangle (see Figure 11-5).

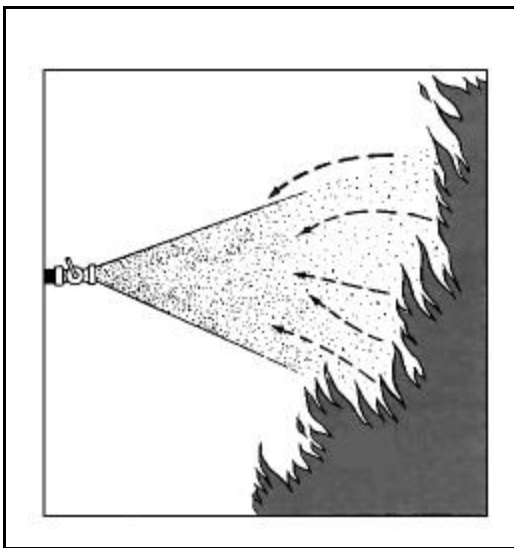

Figure 11-3. Effects of Cooling

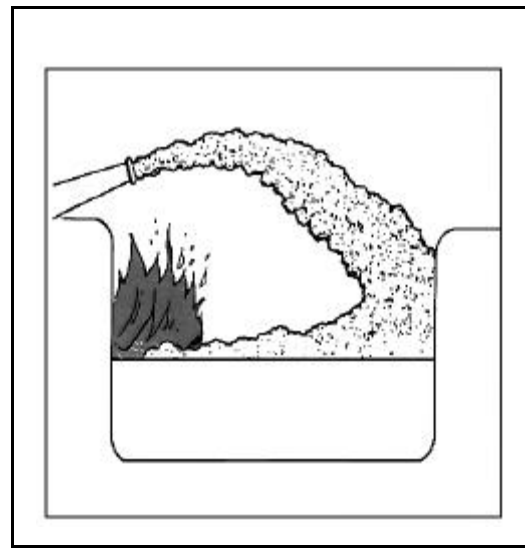

Figure 11-4. Effects of Smothering

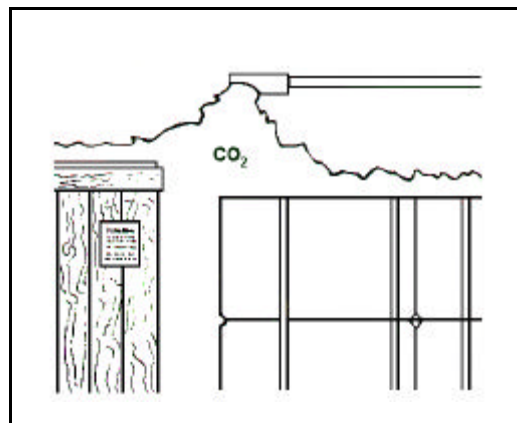

Figure 11-5. Effects of Oxygen Dilution

TYPES OF EXTINGUISHING AGENTS

11-24. Eight extinguishing agents are in common use. Each is applied to the fire as a liquid, gas, or solid, depending on its extinguishing action and physical properties. Some may be used on several types of fires, where others are more limited in use (see Table 11-1).

Table 11-1. The Eight Common Extinguishing Agents

<p>LIQUIDS</p> <p>WATER SPRAY FOAM</p> <p>GASES</p> <p>CARBON DIOXIDE (CO₂) HALON 1301</p> <p>SOLIDS (DRY CHEMICAL)</p> <p>MONOAMMONIUM PHOSPHATE BICARBONATE POTASSIUM BICARBONATE POTASSIUM CHLORIDE</p>
--

EXTINGUISHING AGENTS FOR THE DIFFERENT CLASSES OF FIRE

11-25. It is necessary to use the most suitable type of extinguishing agent to put out a fire. Select an extinguishing agent that will do the task in the least amount of time, cause the least damage, and result in the least danger to crew members (Figure 11-6).

11-26. Class A fires involve common combustible solids such as wood, paper, cloth, and plastics and are most effectively extinguished by water, a cooling agent. Foam and dry chemical may also be used; they act mainly as smothering agents.

11-27. Class B fires involve oils, greases, gases, and other substances that give off large amounts of flammable vapors. A smothering agent is most effective. Water fog, dry chemical, foam, and carbon dioxide (CO₂) may be used. However, if the fire is being supplied with fuel by an open valve or a broken pipe, a valve on the supply side should be shut down. This may extinguish the fire or, at least, make extinguishing less difficult and allow the use of much less extinguishing agent.

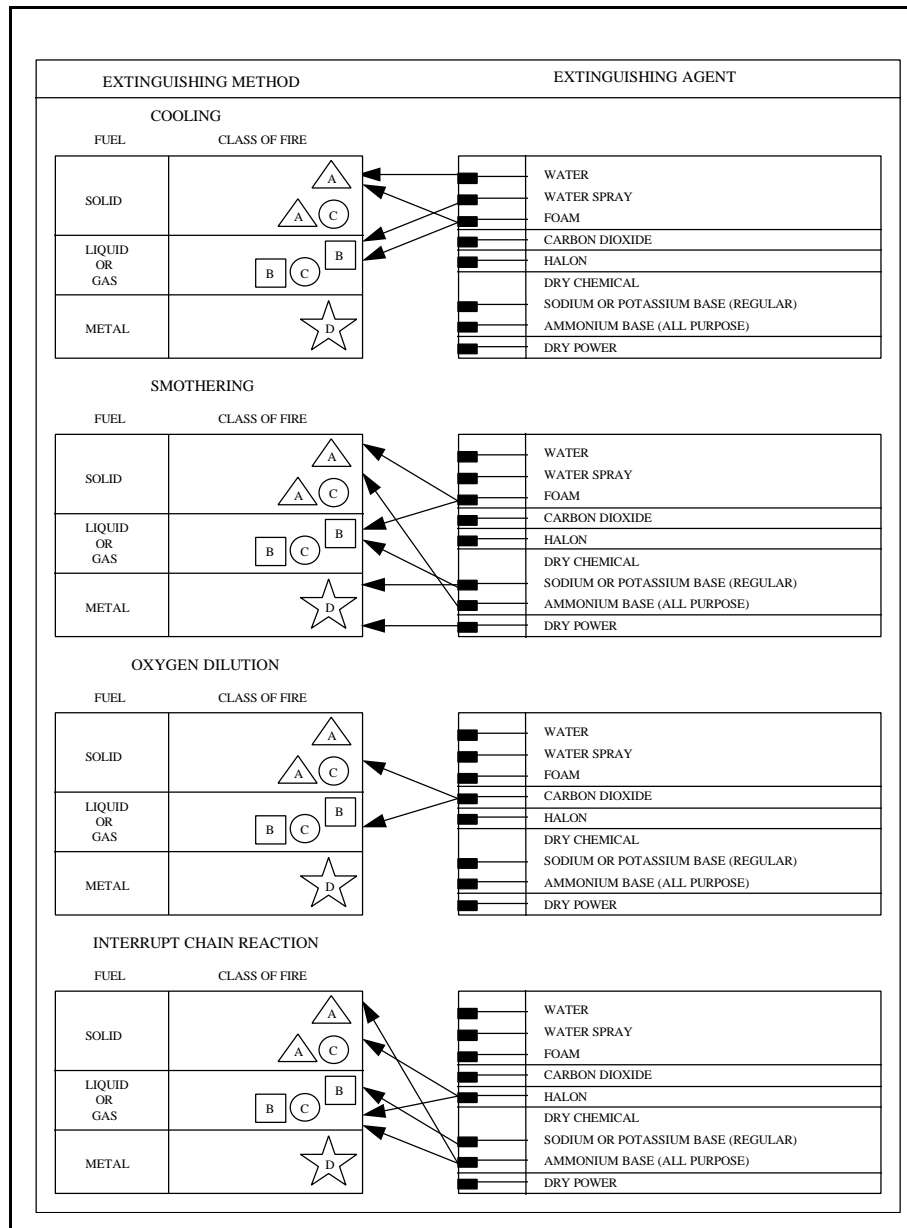

Figure 11-6. Actions of Extinguishing Agents on the Different Classes of Fire

11-28. In a gas fire, it is imperative to shut down the control valve before you extinguish the fire. If the fire were extinguished without shutting down the valve, flammable gas would continue to escape. The potential for an explosion, more dangerous than the fire, would then exist. It might be necessary to extinguish a gas fire before shutting down the fuel supply in order to save a life or to reach the control valve; however, these are the only exceptions.

11-29. Combined Class A and Class B fires involve both solid fuels and flammable liquids or gases. Water spray and foam may be used to smother these fires. These agents also have some cooling effect on the fire. Carbon dioxide has also been used to extinguish such fires in closed spaces.

11-30. Combined Class A and Class C fires involve energized electrical equipment and a non-conducting extinguishing agent must be used. Carbon dioxide, Halon, and dry chemical are the most efficient agents. Carbon dioxide dilutes the oxygen supply, while the others are chain-breaking agents.

11-31. Combined Class B and Class C fires involve flammable liquids or gases and electrical equipment. A nonconducting extinguishing agent is required, such as Halon or dry chemical acting as a chain breaker. They may also, in closed spaces, be extinguished with CO₂.

11-32. Class D fires involve combustible metals such as potassium, sodium and their alloys, magnesium, zinc, and powdered aluminum. They burn on the metal surface at a very high temperature and often with a brilliant flame. Water should not be used on Class D fires, as it may add to the intensity or cause the molten metal to splatter. This, in turn, can extend the fire and inflict painful and serious burns on those in the vicinity.

11-33. Fires in combustible metals are generally smothered and controlled with specialized agents known as dry powders. Dry powders are not the same as dry chemicals, although many people use the terms interchangeably. The agents are used on entirely different types of fires: dry powders are used only to extinguish combustible-metal fires. Dry chemicals may be used on other fires, but not on Class D fires.

WATER

11-34. Water is primarily a cooling agent. It absorbs heat and cools burning materials more effectively than any other of the commonly used extinguishing agents. Water has an important secondary effect. When it turns to steam, it converts from the liquid state to the gaseous (vapor) state. Seawater is just as effective in fighting fire as fresh water.

Straight Streams

11-35. The straight stream, sometimes called the solid stream, is the oldest and most commonly used form of water for fire fighting.

Efficiency of Straight Streams

11-36. The distance that a straight stream travels before breaking up or dropping is called its reach. Reach is important when it is difficult to approach close to a fire. Actually, despite its name, a straight stream is not really straight. Like any projectile, it has two forces acting upon it. The velocity imparted by the nozzle gives it reach, either horizontally or at an upward angle, depending on how the nozzleman aims the nozzle. The other force, gravity, tends to pull the stream down, so the reach ends where the stream encounters the deck.

11-37. Probably less than 10 percent of the water from a straight stream actually absorbs heat from the fire. This is because only a small portion of the water surface actually comes in contact with the fire, and only water that contacts the fire absorbs heat.

Using Straight Streams

11-38. A straight stream should be directed into the seat of the fire. This is important; for the most cooling, the water must touch the material that is actually burning. A solid stream that is aimed at the flames is ineffective. The main use of solid streams is to break up the burning material and penetrate to the seat of a Class A fire.

Low-Velocity Fog Streams

11-39. Low-velocity fog streams are obtained by using an applicator along with a combination nozzle. Applicators are tubes or pipes that are angled at 60° or 90° at the water outlet end. They are stowed for use with the low-velocity head already in place on the pipe. Some heads are shaped somewhat like a pineapple, with tiny holes angled to cause minute streams to bounce off one another and create a mist. Some heads resemble a cage with a fluted arrow inside. The point of the arrow faces the opening in the applicator tubing. Water strikes the fluted arrow and then bounces in all directions, creating a fine mist.

11-40. For 1 1/2-inch nozzles, 4-foot, 60° angle and 10-foot, 90° angle applicators are approved for shipboard use. For 2 1/2-inch nozzles, 12-foot, 90° angle applicators are approved. Other lengths with different angles are sometimes found. The 4-foot applicator is intended for the 1 1/2-inch combination nozzles fitted in propulsion machinery spaces containing oil-fired boilers, internal combustion machinery, or fuel units.

11-41. Low-velocity fog streams are effective in combating Class B fires in spaces where entry is difficult or impossible. Applicators can be poked into areas that cannot be reached with other types of nozzles (Figure 11-7, page 11-12). They are also used to provide a heat shield for fire fighters advancing with foam or high-velocity fog. Low-velocity fog can be used to extinguish small tank fires, especially where the mist from the applicator can cover the entire surface of the tank. However, other extinguishing agents, such as foam and carbon dioxide, are usually more effective.

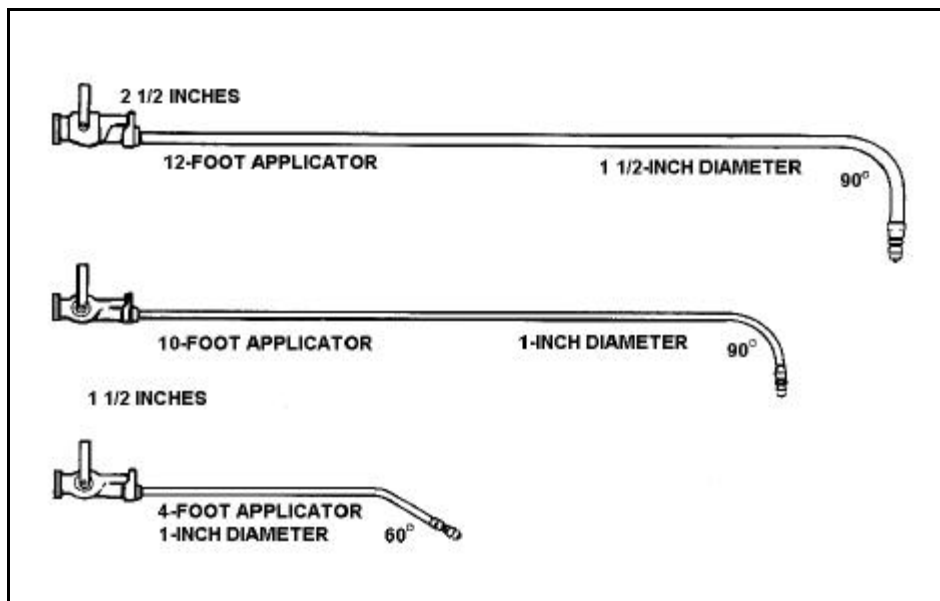

Figure 11-7. Low-Velocity Fog Applicators

Limitations of Fog Streams

11-42. Fog streams do not have the accuracy or reach of straight streams. Improperly used, they can cause injury to personnel, as in a blowback situation. While they can be effectively used on the surface of a deep-seated fire, they are not as effective as solid streams in soaking through and reaching the heart of the fire.

11-43. In some instances, there may be an obstruction between the fire and the nozzleman. Then the stream can be bounced off a bulkhead or the overhead to get around the obstacle (Figure 11-8). This method can also be used to break a solid stream into a spray-type stream, which will absorb more heat. It is useful in cooling an extremely hot passageway that is keeping fire fighters from advancing toward the fire. A combination fog-solid nozzle could be opened to the fog position to achieve the same results.

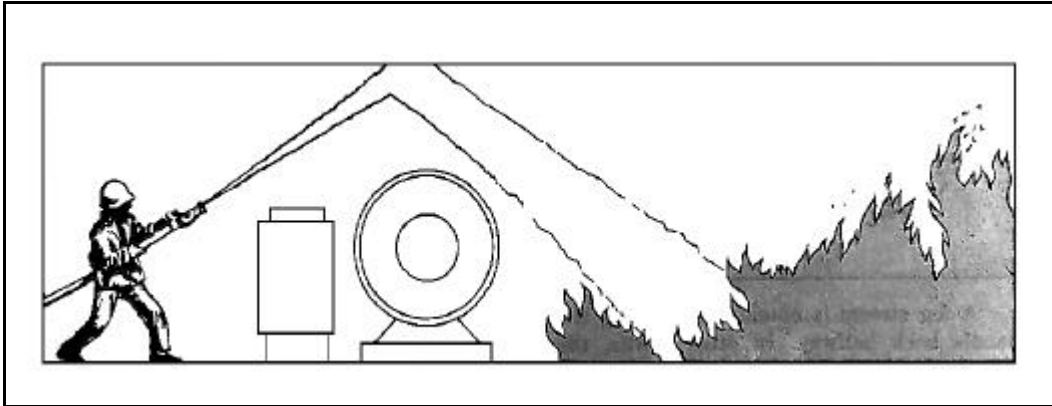

Figure 11-8. Bouncing a Straight Stream Off the Overhead

Fog Streams

11-44. The fog (or spray) nozzle breaks the water stream into small droplets. These droplets have a much larger total surface area than a solid stream. Therefore, a given volume of water in fog form will absorb much more heat than the same volume of water in a straight stream (Figure 11-9).

11-45. The greater heat absorption of fog streams is important where the use of water is limited. Less water need be applied to remove the same amount of heat from a fire. Also, more of the fog stream turns to steam when it hits the fire.

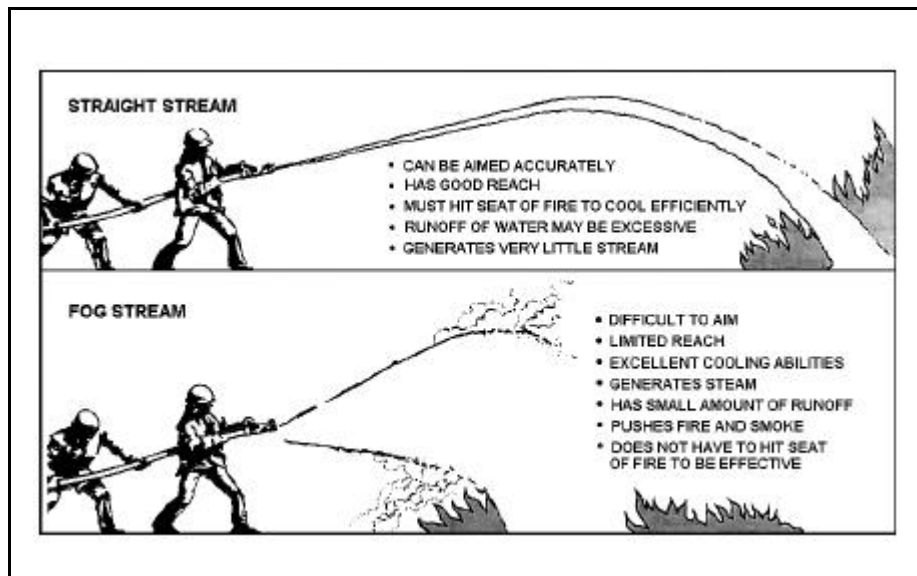

Figure 11-9. Advantages and Disadvantages of Straight and Fog Streams

Combination Nozzle Operation

11-46. Depending on the position of its handle, the combination nozzle will produce a straight stream or high-velocity fog stream. Combination nozzles are available for use with 1 1/2- and 2 1/2-inch hoses. Reducers can be used to attach a 1 1/2-inch nozzle to a 2 1/2-inch hose.

11-47. Create a straight stream by pulling the nozzle handle all the way back toward the operator (Figure 11-10). Create a fog stream by pulling the handle back halfway. In other words, the handle is perpendicular to the plane of the nozzle (Figure 11-11). Shut down the nozzle, from any opened position, by pushing the handle forward as far as it will go (Figure 11-12).

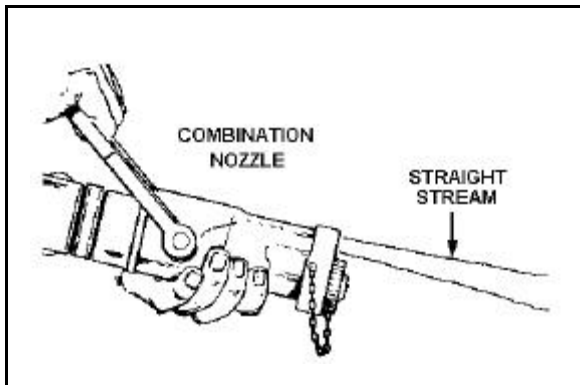

Figure 11-10. Creating a Straight Stream

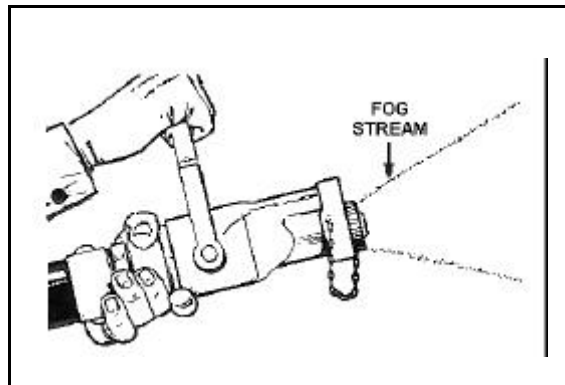

Figure 11-11. Creating a Fog Stream

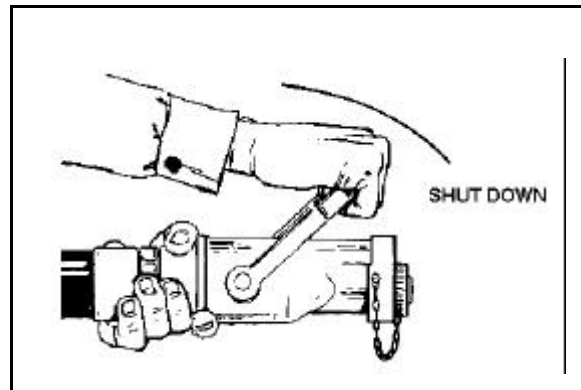

Figure 11-12. Shutting Down the Nozzle

11-48. The low-velocity fog applicator must be attached with the nozzle shut down. First, the high-velocity tip is removed. Then the straight end of the applicator is snapped into the fog outlet and locked with a quarter-turn. A low-velocity fog stream is obtained with the nozzle handle in the fog position (halfway back).

11-49. When any nozzle is to be used, the handle should be in the closed position until the water reaches the nozzle. The hose will bulge out, and the nozzleman will feel the weight of the water. Before pushing the handle to an open position, he should let the entrained air out of the nozzle. To do this, turn a bit sideways with the nozzle and slowly open it until a spatter of water comes out. Now the nozzle is directed at the target. The backup man closes up to the nozzleman and takes some of the weight of the hose and the back pressure from the nozzle. The nozzle is opened to the desired position, and the fire is attacked.

11-50. Straight and fog streams can be very effective against Class A fires in the hands of skilled operators. Fog streams can also be used effectively against Class B fires. However, it is important that crewmen have actual experience in directing these streams during drills. Applicators should also be broken out at drills so crewmen can get the feel of these devices.

FOAM

11-51. Foam is a blanket of bubbles that extinguishes fire, mainly by smothering. Mixing water and a foam-making agent (foam concentrate) produces bubbles. The result is called a foam solution. The various foam solutions are lighter than the lightest of flammable oils. Consequently, when applied to burning oils, they float on the surface of the oil (Figure 11-13).

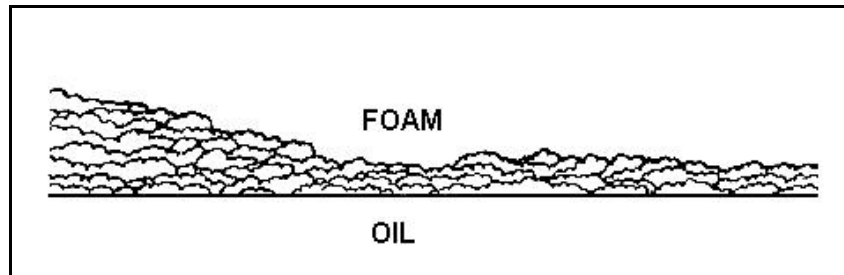

Figure 11-13. Foam

Extinguishing Effects of Foam

11-52. Fire-fighting foam is used to form a blanket on the surface of flaming liquids, including oils. The blanket of foam keeps flammable vapors from leaving the surface and keeps oxygen from reaching the fuel. Fire cannot exist when the fuel and oxygen are separated. The water in the foam also has a cooling effect, which gives foam its Class A extinguishing capability.

11-53. The ideal foam solution should flow freely enough to cover a surface rapidly, yet stick together enough to provide and maintain a vapor-tight blanket. The solution must retain enough water to provide a long-lasting seal. Rapid loss of water would cause the foam to dry out and break down (wither) from the high temperatures associated with fire. The foam should be light enough to float on flammable liquids, yet heavy enough to resist winds.

11-54. The quality of foam is generally defined in terms of its 25 percent drainage time, its expansion ratio, and its ability to withstand heat (burnback resistance). These qualities are influenced by:

- The chemical nature of the foam concentrates.
- The temperature and pressure of the water.
- The efficiency of the foam-making device.

11-55. Foams that lose their water rapidly are the most fluid. They flow around obstructions freely and spread quickly. Such foams would be useful in engine room or machinery space fires. They would be able to flow under and around machinery, floor plates, and other obstructions. The two basic types of foam are chemical and mechanical.

- **Chemical foam.** You can form chemical foam by mixing an alkali (usually sodium bicarbonate) with an acid (usually aluminum sulfate) in water (Figure 11-14). When chemical foam was first introduced, these substances were stored in separate containers. They are now combined in a sealed, airtight container. A stabilizer is added to make the foam tenacious and long-lived. When these chemicals react, they form a foam or froth of bubbles filled with carbon dioxide gas. The carbon dioxide in the bubbles has little or no extinguishing value. Its only purpose is to inflate the bubbles. From 7 to 16 volumes of foam are produced for each volume of water.

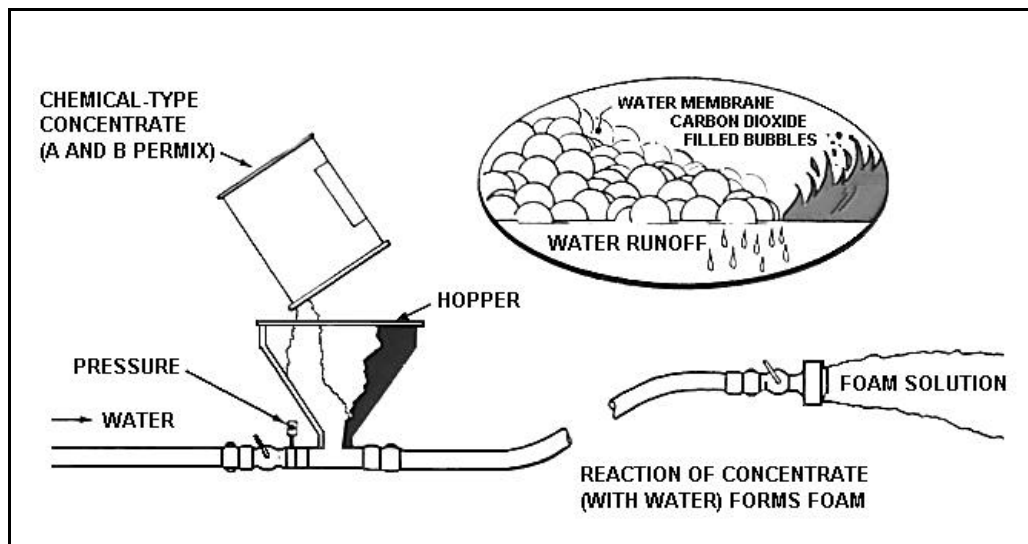

Figure 11-14. Production of Chemical Foam

- **Aqueous film-forming foam.** This foam was developed by the US Naval Research Laboratory to be used in a twinned system: a flammable liquid fire would be quickly knocked down with a dry chemical; then AFFF would be applied to prevent reignition. However, the AFFF proved more effective than expected, and it is now used without the dry chemical. AFFF controls the vaporization of flammable liquids by means of a water film that forms as the foam is applied. Like other foams, it cools and blankets. This double action gives a highly efficient, quick-acting foam cover for combustible-liquid spills. It has a low viscosity and spreads quickly over the burning material. Water draining from this type of foam has a low surface tension, so AFFF can be used on mixed Class A and Class B fires. The draining water penetrates and cools the Class A material, while the film blankets the Class B material. AFFF can be produced from freshwater or seawater. AFFF can be used with, before, or after dry chemicals. AFFF concentrates should not be mixed with the concentrates of other foams, although in foam form they may be applied to the same fire successfully.

Advantages of Foam

11-56. In spite of its limitations, foam is quite effective in combating Class A and Class B fires. Many advantages of foam include the following:

- Very effective smothering agent. Also provides cooling as a secondary effect.
- Sets up a vapor barrier that prevents flammable vapors from rising. The surface of an exposed tank can be covered with foam to protect it from a fire in a neighboring tank.
- Some use on Class A fires because of its water content. AFFF is especially effective, as are certain types of wet-water foam. Wet-water foam is made from detergents; its water content quickly runs out and seeps into the burning material.
- Effective in blanketing oil spills. However, if the oil is running, an attempt should be made to shut down a valve if such action would stop the flow. If that is impossible, the flow should be dammed. Foam should be applied on the upstream side of the dam (to extinguish the fire) and on the downstream side (to place a protective cover over any oil that has seeped through).
- Most effective extinguishing agent for fires involving large tanks of flammable liquids.
- Made with freshwater or seawater and hard or soft water.

- Does not break down readily; it extinguishes fire progressively when applied at an adequate rate.
- Stays in place, covers, and absorbs heat from materials that could cause reignition.
- Uses water economically. Does not tax the ship's fire pumps.
- Concentrates are not heavy, and foam systems do not take up much space.

Limitations on the Use of Foam

11-57. Foams are effective extinguishing agents when used properly. However, some limitations on foam include the following:

- Because they are aqueous (water) solutions, they are electrically conductive and should not be used on live electrical equipment.
- Like water, foams should not be used on combustible-metal fires.
- Many must not be used with dry chemical extinguishing agents. AFFF is an exception to this rule and may be used in a joint attack with dry chemical.
- Sufficient foam must be on hand to make sure that the entire surface of the burning material can be covered. In addition, there must be enough foam to replace foam that is burned off and to seal breaks in the foam surface.

11-58. The premixed foam powder may be stored in cans and introduced into the water during firefighting operations. For this, a device called a foam hopper is used. The two chemicals may be premixed with water to form an aluminum sulfate solution and a sodium bicarbonate solution. The solutions are then stored in separate tanks until the foam is needed. At that time, the solutions are mixed to form the foam.

11-59. Many chemical foam systems, both aboard ship and in shore installations, are still in use. However, these systems are being phased out in favor of the newer mechanical foam or, as it is sometimes called, air foam.

Mechanical (Air) Foam

11-60. Mechanical foam is produced by mixing a foam concentrate with water to produce a foam solution (Figure 11-15). The turbulent mixing of air and the foam solution produces bubbles. As the name air foam implies, the bubbles are filled with air. Aside from the workmanship and efficiency of the equipment, the degree of mixing determines the quality of the foam. The design of the equipment determines the quantity of foam produced.

11-61. There are several types of mechanical foams. They are similar in nature, but each has its own special fire-fighting capabilities. Mechanical foams are produced from proteins, detergents (which are synthetics), and surfactants. The surfactants are a large group of compounds that include detergents, wetting agents, and liquid soaps. Surfactants are used to produce aqueous film-forming foam, commonly referred to as AFFF.

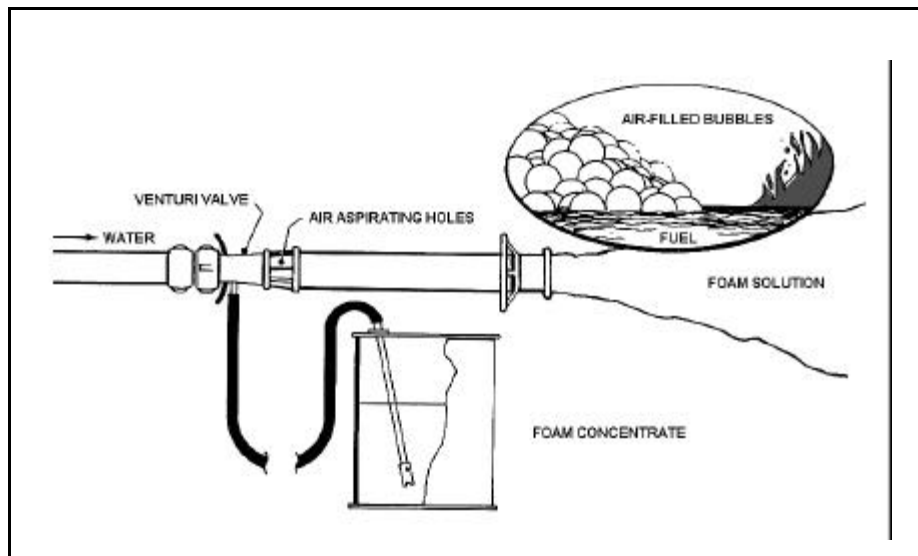

Figure 11-15. Production of Mechanical (Air) Foam

CARBON DIOXIDE

11-62. CO₂ extinguishing systems have, for a long time, been approved for ship installation as well as for industrial occupancies ashore. Aboard ship, carbon dioxide has been approved for cargo and tank compartments, spaces containing internal combustion or gas-turbine main propulsion machinery, and other spaces.

Extinguishing Properties of Carbon Dioxide

11-63. Carbon dioxide extinguishes fire mainly by smothering. It dilutes the air surrounding the fire until the oxygen content is too low to support combustion. For this reason, it is effective on Class B fires, where the main consideration is to keep the flammable vapors separated from oxygen in the air. CO₂ has a very limited cooling effect. It can be used on Class A fires in confined spaces, where the atmosphere may be diluted sufficiently to stop combustion. However, CO₂ extinguishing takes time. The concentration of carbon dioxide must be maintained until all the fire is out. Constraint and patience are needed.

11-64. Carbon dioxide is sometimes used to protect areas containing valuable articles. Unlike water and some other agents, carbon dioxide dissipates without leaving a residue. Since it does not conduct electricity, it can be used on live electrical equipment. However, fire fighters must maintain a reasonable distance when using a portable CO₂ extinguisher or a hose line from a semiportable system on high voltage gear.

Uses of Carbon Dioxide

11-65. Carbon dioxide is used primarily for Class B and Class C fires. It may also be used to knock down a Class A fire. It is particularly effective on fires involving:

- Flammable oils and greases.
- Electrical and electronic equipment, such as motors, generators, and navigational devices.
- Hazardous and semihazardous solid materials (such as some plastics, except those that contain their own oxygen [like nitrocellulose]).
- Machinery spaces, engine rooms, paint, and tool lockers.
- Cargo spaces which can be flooded with carbon dioxide.
- Galleys and other cooking areas, such as diet kitchens.
- Compartments containing high value cargo, delicate machinery, and other material that would be ruined or damaged by water or water-based extinguishing agents.
- Spaces where after-fire cleanup would be a problem.

Limitations on the Use of Carbon Dioxide

11-66. CO₂ portable extinguishers are used primarily for small electrical fires (Class C) and have limited effectiveness on Class B fires. Their use will be confined to Class B pool fires no greater than four square feet. Successful operation requires close approach due to the extinguisher's characteristics short range (4 to 6 feet).

- **Effectiveness.** CO₂ is not effective on substances that contain their own oxygen (oxidizing agents).
- **Outside use.** To be fully effective, the gas must be confined. For this reason, CO₂ is not as effective outside as it is in a confined space. This does not mean that it cannot be used outside.
- **Possibility of reignition.** Compared with water, carbon dioxide has a very limited cooling capacity. It may not cool the fuel below its ignition temperature and it is more likely than other extinguishing agents to allow reflash.

- **Hazards.** Although carbon dioxide is not poisonous to the human system, it is suffocating in the concentration necessary for extinguishment. A person exposed to this concentration would suffer dizziness and unconsciousness. Unless removed quickly to fresh air, the victim could die.

DRY CHEMICALS

11-67. Dry chemical extinguishing agents are chemicals in powder form. They should not be confused with dry powders, which are intended only for combustible metal fires.

Types of Chemical Extinguishing Agents

11-68. Five different types of dry chemical extinguishing agents are in use. Like other extinguishing agents, dry chemicals may be installed in a fixed system or in portable and semiportable extinguishers.

- **Sodium bicarbonate.** This is the original dry chemical extinguishing agent. It is generally referred to as regular dry chemical and is widely used because it is the most economical dry chemical agent. It is particularly effective on animal fats and vegetable oils because it chemically changes these substances into nonflammable soaps. Therefore, sodium bicarbonate is used extensively for galley range, hood, and duct fires. There is one possible problem with sodium bicarbonate: fire has been known to flash back over the surface of an oil fire when this agent is used.

- **Potassium bicarbonate (Purple-K).** Although usually used alone, this dry chemical was originally developed to be used with AFFF in a twinned system. It is most effective on liquid fuel fires in driving flames back and has a good reputation for eliminating flashback. It is more expensive than sodium bicarbonate.
- **Potassium chloride.** Potassium chloride was developed as a dry chemical that would be compatible with protein-type foams. Its extinguishing properties are about equal to those of potassium bicarbonate. One drawback is its tendency to cause corrosion after it has extinguished a fire.
- **Urea potassium bicarbonate.** This is a British development. It is not widely used because it is expensive.

- **Monoammonium phosphate (ABC, multipurpose).** Monoammonium phosphate is called a multipurpose dry chemical because it can be effective on Class A, Class B, and Class C fires. Ammonium salts interrupt the chain reaction of flaming combustion. The phosphate changes into metaphosphoric acid, a glassy fusible material, at fire temperatures. The acid covers solid surfaces with a fire retardant coating. Therefore, this agent can be used on fires involving ordinary combustible materials such as wood and paper, as well as on fires involving flammable oils, gases, and electrical equipment. However, it may only control, but not fully extinguish, a deep-seated fire.

Extinguishing Effects of Dry Chemicals

11-69. Dry chemical agents extinguish fire by cooling, smothering, shielding of radiant heat, and by breaking the combustion chain.

- **Cooling.** No dry chemical exhibits any great capacity for cooling. However, a small amount of cooling takes place simply because the dry chemical is at a lower temperature than the burning material.
- **Smothering.** When dry chemicals react with the heat and burning material, some carbon dioxide and water vapor are produced. These dilute the fuel vapors and the air surrounding the fire. The result is a limited smothering effect.
- **Shielding of radiant heat.** Dry chemicals produce an opaque cloud in the combustion area. This cloud reduces the amount of heat that is radiated back to the heart of the fire, that is, the opaque cloud absorbs some of the radiation feedback that is needed to sustain the fire.

Uses of Dry Chemicals

11-70. Monoammonium phosphate (ABC, multipurpose) dry chemical may, as its name implies, be used on Class A, Class B, and Class C fires and combinations of these. However, as noted above, ABC dry chemical may only control, but not extinguish, some deep-seated Class A fires and an auxiliary extinguishment method, such as a water hose line, is required. All dry chemical agents may be used to extinguish fires involving the following:

- Flammable oils and greases.
- Electrical equipment.
- Hoods, ducts, and cooking ranges in galleys and diet kitchens.
- The surfaces of baled textiles.

- Certain combustible solids such as pitch, naphthalene, and plastics (except those that contain their own oxygen).
- Machinery spaces, engine rooms, paint lockers, and tool lockers.

Dry chemical extinguishing agents are very effective on gas fires. However, gas flames should not be extinguished until the supply of fuel has been shut down upstream of the fire.

Limitations on the Use of Dry Chemicals

11-71. The limitations on the use of dry chemicals are as follows:

- The discharge of large amounts of dry chemicals could affect people in the vicinity.
- Like other extinguishing agents that contain no water, dry chemicals are not effective on materials that contain their own oxygen.
- Dry chemicals may deposit an insulating coating on electronic or telephonic equipment, affecting the operation of the equipment.
- Dry chemicals are not effective on combustible metals such as magnesium, potassium, sodium, and their alloys, and in some cases may cause a violent reaction.
- Where moisture is present, a dry chemical agent may corrode or stain surfaces on which it settles.

WARNING

DRY CHEMICAL EXTINGUISHING AGENTS ARE CONSIDERED NONTOXIC, BUT THEY MAY HAVE IRRITATING EFFECTS WHEN BREATHED. FOR THIS REASON, A WARNING SIGNAL, SIMILAR TO THE ONE USED IN CARBON DIOXIDE SYSTEMS, SHOULD BE INSTALLED IN ANY SPACE THAT MIGHT BE TOTALLY FLOODED WITH DRY CHEMICALS. BREATHING APPARATUSES AND LIFELINES MUST ALSO BE AVAILABLE IN CASE CREWMEN MUST ENTER THE SPACE BEFORE IT IS ENTIRELY VENTILATED. TABLE 11-2 DESCRIBES THE SIGNALS THAT ARE USED BETWEEN THE OBA WEARER AND TENDER.

Table 11-2. Lifeline Signals Between OBA Wearer and Tender

PULLS ON LINE	MEANING	
	TENDER TO WEARER	WEARER TO TENDER
1	Are you all right?	I am all right.
2	Advance.	I am going ahead.
3	Back out.	Take up my slack.
4	Come out immediately.	Send help.

DRY POWDERS

11-72. Dry powders were developed to control and extinguish fires in combustible metals. These are Class D fires which involve the following metals:

- Magnesium.
- Potassium.
- Sodium and their alloys.
- Titanium.
- Zirconium.
- Powdered or fine aluminum.
- Some lesser known metals.

As mentioned earlier, dry chemicals and dry powders are not the same. Dry powders are the only extinguishing agents that can control and extinguish metal fires without causing violent reactions. Other extinguishing agents may accelerate or spread the fire, injure personnel, cause explosions, or create conditions more hazardous than the original fire. Dry powders act mainly by smothering, although some agents also provide cooling.

11-73. Two commercially available dry powders are composed mostly of graphite. The graphite cools the fire and creates a very heavy smoke that helps smother the fire. These agents are also effective on all the metals listed above. They are applied with a scoop or shovel.

11-74. Dry powder with a sodium chloride (salt) base is propelled from portable extinguishers by carbon dioxide and from large containers or fixed systems by nitrogen. The powder is directed over the burning metal. When it drops, it forms a crust on the metal and smothers the fire. Like the graphite types, it is effective on the combustible metals mentioned above.

HALOGENATED EXTINGUISHING AGENTS (HALON)

11-75. Halogenated extinguishing agents are made up of carbon and one or more of the halogen elements: fluorine, chlorine, bromine, and iodine. Halon 1301 enters the fire area as a gas. Most authorities agree that the Halon acts as a chain breaker. However, it is not known whether it will slow the chain reaction, break it up, or cause some other reaction. Halon 1301 is stored and shipped as a liquid under pressure. When released in the protected area, it vaporizes to an odorless, colorless gas and is propelled to the fire by its storage pressure. Halon 1301 does not conduct electricity. The extinguishing properties of Halon 1301 allow its use on a number of different types of fire. These include:

- Fires in electrical equipment.
- Fires in engine rooms, machinery spaces, and other spaces involving flammable oils and greases.
- Class A fires in ordinary combustibles. However, if the fire is deep-seated, a longer soaking time may be needed or a standby hose line may be used to complete the extinguishment.
- Fires in areas where articles of high value may be stored and are damaged by the residue of other agents.
- Fires involving electronic computers and control rooms.

There are few limitations on the use of Halon agents. However, they are not suited for fighting fires in materials containing their own oxygen or combustible metals and hydrides.

WARNING

HALON 1301 MAY CAUSE DIZZINESS AND IMPAIRED COORDINATION IF INHALED. IF HALON 1301 IS TO BE USED FOR THE TOTAL FLOODING OF NORMALLY OCCUPIED SPACES, AN EVACUATION ALARM MUST BE PROVIDED. PERSONNEL SHOULD LEAVE THE AREA PROMPTLY ON HEARING THE ALARM. WHEN A HALON 1301 EXTINGUISHER IS USED, THOSE NOT DIRECTLY INVOLVED IN THE OPERATION SHOULD LEAVE THE AREA IMMEDIATELY. THE EXTINGUISHER OPERATOR SHOULD STEP AWAY AS SOON AS THE APPLIANCE IS DISCHARGED. THE AREA SHOULD BE VENTED WITH FRESH AIR BEFORE IT IS REENTERED. IF IT IS NECESSARY TO REMAIN IN OR ENTER AN AREA WHERE HALON 1301 HAS BEEN DISCHARGED, A BREATHING APPARATUS AND LIFELINES SHOULD BE USED. THE ONLY VALID REASON FOR SUCH ENTRY WOULD BE TO SAVE A LIFE OR TO MAINTAIN CONTROL OF THE SHIP.

HEPTAFLUOROPROPANE (HFC227EA) OR FM-200

11-76. HFC227ea or FM-200 is a clear, odorless gas. It has been developed as a total compartment flooding system to replace Halon 1301. As good environmental stewards, the Army has decided on a program of removal of all Halon 1301 fixed firefighting systems aboard vessels. FM-200 will provide the same firefighting capabilities as Halon with a much less harmful effect on the environment. FM-200 is not an ozone-depleting chemical. It works in much the same manner as Halon. The same precautions for the use of Halon should be adhered to when using FM-200. FM-200 can potentiate the effects of adrenalin at concentrations greater than 9 percent. This chemical also produces hydrogen fluoride, a corrosive, when super heated.

PORTABLE FIRE EXTINGUISHERS

11-77. Portable extinguishers can be carried to the fire area for a fast attack. However, they contain a limited supply of extinguishing agent. The agent is quickly expelled from the extinguisher; in most cases, continuous application can be sustained for only a minute or less. For this reason, it is extremely important to back up the extinguisher with a hose line. If the extinguisher does not have the capacity to put the fire out completely, the hose line can be used to finish the job. A crewman who is using an extinguisher cannot advance a hose line at the same time, so the alarm must be sounded as soon as a fire is discovered to alert the ship's personnel to the situation.

11-78. There is a right way and many wrong ways to use a portable fire extinguisher. Crew members who have had little training with these appliances waste extinguishing agent through improper application. At the same time, untrained personnel tend to overestimate their extinguishing ability. Periodic training sessions, including practice with the types of extinguishers carried onboard are the best insurance against inefficient use of this equipment. Extinguishers that are due to be discharged and inspected may be used in these training sessions.

CLASSES OF FIRE EXTINGUISHERS

11-79. Every portable extinguisher is classified in two ways, with one or more letters and with a numeral. The letter or letters indicate the classes of fires on which the extinguisher may be used. These letters correspond exactly to the four classes of fires. For example, Class A extinguishers may be used only on Class A fires--those involving common combustible materials. Class AB extinguishers may be used on fires involving wood or diesel oil or both.

11-80. The numeral indicates either the relative efficiency of the extinguisher or its size. This does not mean the size of fire on which to use the extinguisher; rather, the numeral indicates how well the extinguisher will fight a fire of its class.

11-81. The NFPA rates extinguisher efficiency with Arabic numerals. The UL tests extinguishers on controlled fires to determine their NFPA ratings. A rating such as 2A or 4A on an extinguisher would be an NFPA rating. (A 4A rating will extinguish twice as much Class A fire as a 2A rating; a 20B rating will extinguish four times as much Class B fire as a 5B rating.)

11-82. The Coast Guard uses Roman numerals to indicate the sizes of portable extinguishers. The numeral I indicates the smallest size and V the largest. A BIII Coast Guard rating indicates a medium-sized extinguisher suitable for fires involving flammable liquids and gases. The Coast Guard ratings of the different types of extinguishers are shown in Table 11-3.

Table 11-3. United States Coast Guard Extinguisher Classification Table

TYPE	SIZE	WATER (GALLONS)	FOAM (GALLONS)	DIOXIDE (POUNDS)	CHEMICAL (POUNDS)
A	II	2 1/2	2 1/2		
B	I		1 1/4	4	2
B	II		2 1/2	15	10
B	III		12	35	20
B	IV		20	50	30
B	V		40	100	50

C	I		4	2
C	II		15	10

TEST AND INSPECTION

11-83. Army fire regulations require masters or persons in charge to have portable and semiportable fire extinguishers and fixed fire-extinguishing systems tested and inspected "at least once in every 12 months." When tests are completed, a tag will be placed on each extinguisher, showing the date and the person who completed the tests.

GENERAL SAFETY RULES FOR PORTABLE EXTINGUISHERS

11-84. There are some general safety rules you should follow when using portable extinguishers. These are as follows:

- When you discover a fire, call out your discovery, sound the fire alarm, and summon help.
- Never pass the fire to get to an extinguisher. You can get trapped in a dead-end passageway.
- If you must enter a room or compartment to combat the fire, keep an escape path open. Never let the fire get between you and the door.
- If you enter a room or compartment and your attack with a portable extinguisher fails, get out immediately. Close the door to confine the fire and prepare to fight the fire while waiting for previously summoned help. Your knowledge of the situation will aid those responding.

WATER EXTINGUISHERS

11-85. Extinguishers that use water or a water solution, as the extinguishing agents, are suitable only for Class A fires. There are five types of water extinguishers, but only two are currently produced. In 1969, the manufacture of the inverting types of extinguishers (the soda-acid, foam, and cartridge-operated) was discontinued. However, since a large number of inverting extinguishers are still in use, they will be discussed along with the stored-pressure water extinguisher.

Soda-Acid Extinguisher

11-86. The soda-acid extinguisher (Figure 11-16) comes only in a 2 1/2-gallon size that carries an NFPA rating of 2A. It weighs about 30 pounds when charged, has a reach of 30 to 40 feet, and expends itself in about 55 seconds. The shell of the extinguisher is filled with a solution of 1 1/2 pounds of sodium bicarbonate in 2 1/2 gallons of water. The screw-on cap contains a cage that holds an 8-ounce bottle, half filled with sulphuric acid, in an upright position. A loose stopper in the top of the acid bottle prevents acid from splashing out before the extinguisher is to be used.

11-87. The extinguisher is carried to the fire by means of the top handle. At the fire, the extinguisher is inverted, the acid mixes with the sodium bicarbonate solution forming carbon dioxide gas, and the pressure of the CO_2 propels the water out through the nozzle. The stream must be directed at the seat of the fire and moved back and forth to hit as much of the fire as possible. The nozzle should be aimed at the fire until the entire content of the extinguisher is discharged. Remember that water is available for less than a minute!

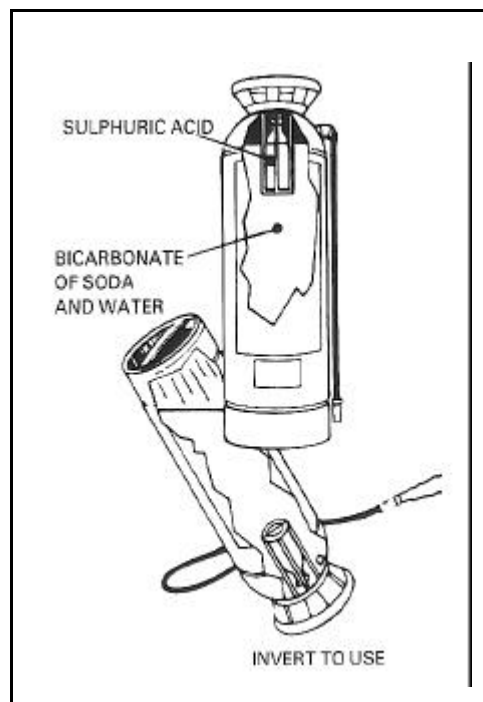

Figure 11-16. Water (Soda-Acid) Extinguisher

11-88. The extinguishing agent, sodium bicarbonate solution mixed with acid, is more corrosive than plain water. The operator should avoid getting the agent on his skin or in his eyes, as the acid could cause burning. Soda-acid extinguishers must also be carefully maintained. When the extinguisher is inverted, a pressure of 130 psi or more is generated. If the container is corroded or otherwise damaged, this pressure could be sufficient to burst the container.

Cartridge-Operated Water Extinguisher

11-89. The cartridge-operated water extinguisher (Figure 11-17) is similar in size and operation to the soda-acid extinguisher. The most common size is 2 1/2 gallons, with an NFPA rating of 2A. It has a range of 30 to 40 feet. The container is filled with water or an antifreeze solution. The screw-on cap contains a small cylinder of CO₂; when the cylinder is punctured, the gas provides the pressure to propel the extinguishing agent.

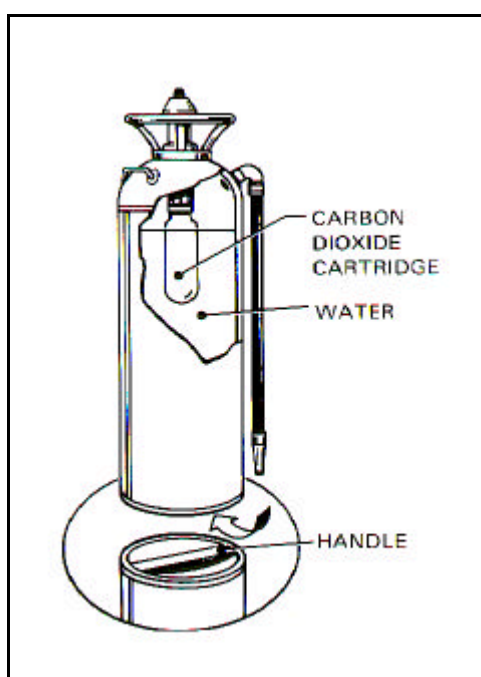

Figure 11-17. Cartridge-Operated Water Extinguisher

11-90. When using the extinguisher, it is first carried to the fire, then inverted and bumped against the deck (Figure 11-18, step 1). This ruptures the CO₂ cylinder and expels the water. The stream should be directed at the seat of the fire (Figure 11-18, step 2). The nozzle should be moved back and forth to quench as much of the burning material as possible in the short time available (Figure 11-18, step 3). The discharge time is less than 1 minute. The entire contents of the extinguisher must be discharged, since the flow cannot be shut off.



Figure 11-18. Using the Cartridge-Operated Extinguisher

11-91. As with the soda-acid extinguisher, the container is not subject to pressure until it is put to use. Any weakness in the container may not become apparent until the container fails.

Pin-Type Cartridge-Operated Extinguisher

11-92. A newer version of the cartridge-operated water extinguisher need not be inverted for use. Instead, you can pull the pin out of the cartridge with the extinguisher in an upright position. A lever is squeezed to discharge the extinguishing agent (water or antifreeze solution).

11-93. The cartridge is fitted with a pressure gauge. The gauge should be checked periodically to ensure that the cartridge pressure is within its operating range. Otherwise, maintenance is similar to that for the inverting-type cartridge extinguisher.

Stored-Pressure Water Extinguisher

11-94. The stored-pressure water extinguisher (Figure 11-19, page 11-32) is the most commonly used portable fire-fighting appliance. The 2 1/2-gallon size has an NFPA rating of 2A. It weighs about 30 pounds and has a horizontal range of 35 to 40 feet. In continuous operation, it will expend its water in about 55 seconds. However, it may be used intermittently to extend its operational time.

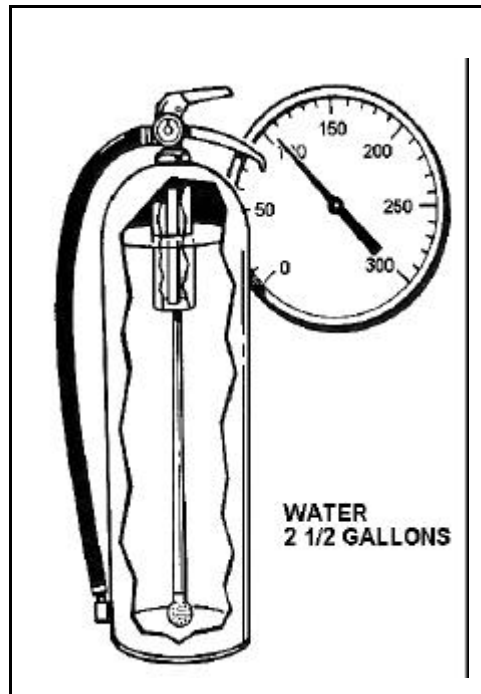

Figure 11-19. Stored-Pressure Water Extinguisher

11-95. The container is filled with water, or an antifreeze solution, to within about 6 inches of the top (most extinguishers have a fill mark stamped on the container). The screw-on cap holds a lever-operated discharge valve, a pressure gauge, and an automobile tire-type valve. The extinguisher is pressurized through the air valve, with either air or an inert gas, such as nitrogen. The normal charging pressure is about 100 psi. The gauge allows the pressure within the extinguisher to be checked at any time. Most gauges are color-coded to indicate normal and abnormal pressures.

11-96. The extinguisher is carried to the fire, and the ring pin or other safety device is removed. The operator aims the nozzle with one hand and squeezes the discharge lever with the other hand. The stream should be directed at the seat of the fire. It should be moved back and forth to make sure the burning material is completely covered. Short bursts can be used to conserve the limited supply of water.

11-97. As the flames are knocked down, the operator may move closer to the fire. By placing the tip of one finger over the nozzle, the operator can get a spray pattern that will cover a wider area.

FOAM EXTINGUISHERS

11-98. Foam extinguishers are similar in appearance to those discussed previously, but have a greater extinguishing capability. The most common size is 2 1/2 gallons, with an NFPA rating of 2A:4B. This indicates that the extinguisher may be used on both Class A and Class B fires. It has a range of about 30 to 40 feet and a discharge duration of slightly less than a minute.

11-99. The extinguisher is charged by filling it with two solutions that are kept separated (in the extinguisher) until ready to use. These solutions are commonly called the A and B solutions. Their designations have nothing to do with fire classifications.

11-100. The foam extinguisher is carried to the fire right side up and then inverted. This mixes the two solutions, producing a liquid foam and CO₂ gas. The CO₂ acts as the propellant and fills the foam bubbles. The liquid foam expands to about eight times its original volume. This means the 2 1/2-gallon extinguisher will produce 18 to 20 gallons of foam.

11-101. The foam should be applied gently on burning liquids. Do this by directing the stream in front of the fire and causing the foam to bounce back onto the fire. The stream may also be directed against the back wall of a tank or a structural member to allow the foam to run down and flow over the fire. Chemical foam is stiff and flows slowly. For this reason, the stream must be directed to the fire from several angles for complete coverage of the burning materials (see also Figure 11-20, page 11-34). For fires involving ordinary combustible materials, the foam may be applied in the same way, as a blanket, or the force of the stream may be used to get the foam into the seat of the fire.

11-102. Foam extinguishers are subject to freezing and cannot be stored in temperatures below 4.4° C (40° F). Once activated, these extinguishers will expel their entire foam content; it should all be directed onto the fire. As with other pressurized extinguishers, the containers are subject to rupture when their contents are mixed. Maintenance consists mainly of annual discharging, inspection, cleaning, and recharging.



Figure 11-20. Operating a Foam Extinguisher on a Flammable Liquid Fire

CARBON DIOXIDE (CO₂) EXTINGUISHER

11-103. These are used primarily on Class B and Class C fires. The most common sizes of portable extinguishers contain from 5 to 20 pounds of CO₂, not including the weight of the relatively heavy shell. The CO₂ is mostly in the liquid state, at a pressure of 850 psi at 21° C (70° F). The 5-pound size is rated 5B:C and the 15-pound size has a rating of 10B:C. Depending on the size of the extinguisher, the range varies between 3 to 8 feet and the duration between 8 to 30 seconds.

11-104. Carry the extinguisher to the fire in an upright position. The short range of the CO₂ extinguisher means the operator must get fairly close to the fire. Place the extinguisher on the deck and remove the locking pin. The discharge is controlled either by opening a valve or by squeezing two handles together. The operator must grasp the hose handle and not the discharge horn (see Figure 11-21). The CO₂ expands and cools very quickly as it leaves the extinguisher. The horn gets cold enough to frost over and cause severe frostbite. When a CO₂ extinguisher is used in a confined space, the operator should guard against suffocation by wearing a breathing apparatus.

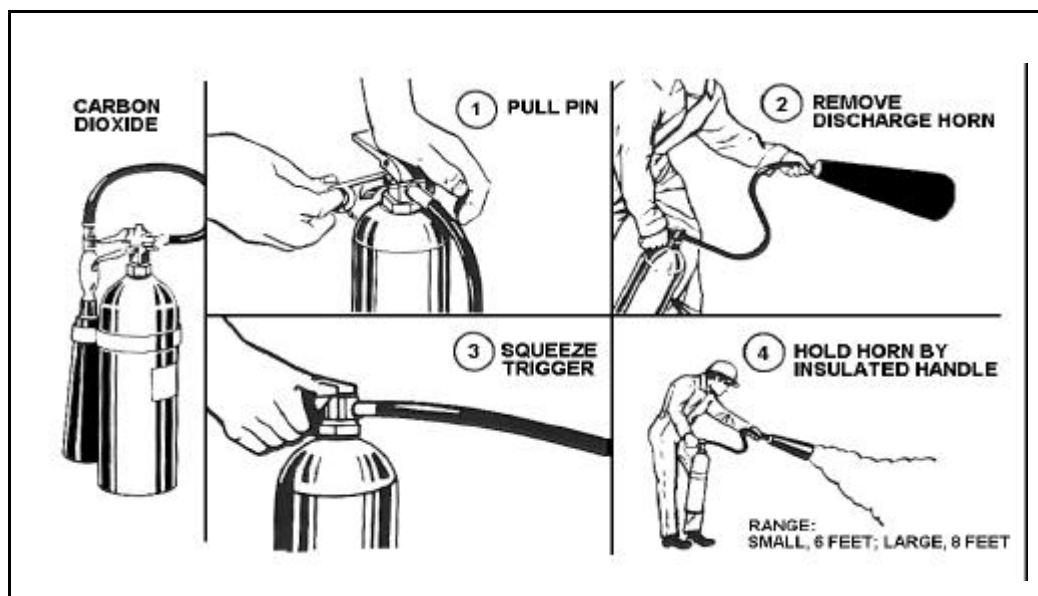

Figure 11-21. Procedure for Using the CO₂ Extinguisher

Class B Fires

11-105. The horn should be aimed first at the base of the fire nearest the operator. The discharge should be moved slowly back and forth across the fire. At the same time, the operator should move forward slowly. The result should be a “sweeping” of the flames off the burning surface, with some carbon dioxide “snow” left on the surface.

11-106. Whenever possible, a fire on a weather deck should be attacked from the windward side. This will allow the wind to blow the heat away from the operator and to carry the CO₂ to the fire. CO₂ extinguishers generally do not perform well in windy conditions. The blanket of CO₂ gas does not remain on the fire long enough to permit the fuel to cool down.

Class C Fires

11-107. The discharge should be aimed at the source of a fire that involves electrical equipment. The equipment should be de-energized as soon as possible to eliminate the chance of shock and the source of ignition.

Maintenance of CO₂ Extinguishers

11-108. Several times each year, CO₂ extinguishers should be examined for damage and to make sure that they are not empty. At annual inspection, these extinguishers should be weighed. The manufacturer should recharge any extinguisher that has lost more than 10 percent of its CO₂ weight. Recharge a CO₂ extinguisher after each use, even if it was only partly discharged.

DRY POWDER EXTINGUISHER

11-109. Dry powder (not dry chemical) is the only extinguishing agent that may be used on combustible metal (Class D) fires. The only dry power extinguisher (Figure 11-22) for Class D fires is a 30-pound cartridge-operated model that looks much like the cartridge-operated dry chemical extinguisher. One difference is that the Class D extinguisher has a range of only 6 to 8 feet. The extinguishing agent is sodium chloride, which forms a crust on the burning metal.

11-110. To operate, remove the nozzle from its retainer and press the puncture lever. This allows the propellant gas (CO₂ or nitrogen) to activate the extinguisher. The operator then aims the nozzle and squeezes the grips to apply the powder to the surface of the burning metal.

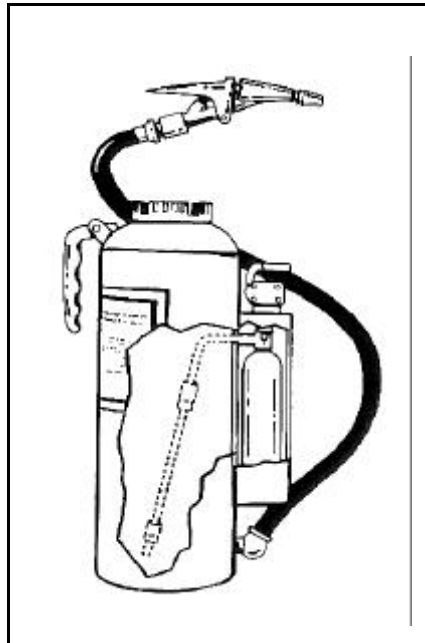

Figure 11-22. Dry Power Extinguisher

11-111. The operator should begin the application of dry powder about 6 to 8 feet from the fire. The squeeze grips may be adjusted for the desired rate of flow to build a thick layer of powder over the entire involved area. The operator must be careful not to break the crust that forms when the powder hits the fire (see also Figure 11-23).

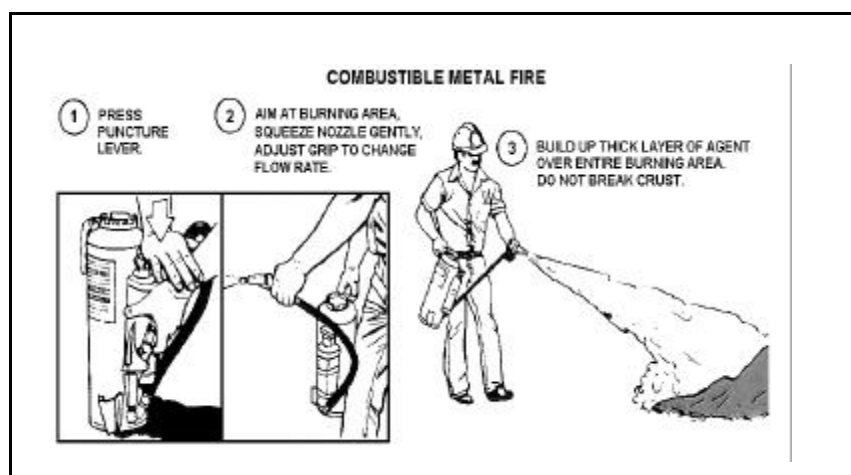

Figure 11-23. Procedure for Operating the Dry Powder Extinguisher

11-112. A large amount of dry powder is sometimes needed to extinguish a very small amount of burning metal. A brown discoloration indicates a hot spot, where the layer of dry powder is too thin. An additional agent should be applied to the discolored areas. When the fire involves small metal chips, the agent should be applied as gently as possible so the force of the discharge does not scatter burning chips.

11-113. Class D dry powder also comes in a container, for application with a scoop or shovel. This agent should also be applied very gently. A thick layer of powder should be built up, and the operator should be careful not to break the crust that forms.

HALON EXTINGUISHERS

11-114. Halon 1301 (with an NFPA rating of 5 B:C) is available only in a 2 1/2-pound portable extinguisher. Its horizontal range is from 4 to 6 feet and its discharge time is 8 to 10 seconds. The extinguishing agent is pressurized in a lightweight steel or aluminum alloy shell. The cap contains the discharge control valve and discharge nozzle.

11-115. Carry the extinguisher to the fire and then remove the locking pin. Control the discharge by squeezing the control valve-carrying handle. Direct the Halon at the seat of a Class B fire and apply with a slow, side-to-side sweeping motion. It should be directed at the source of an electrical fire (see Figure 11-24, page 11-38).

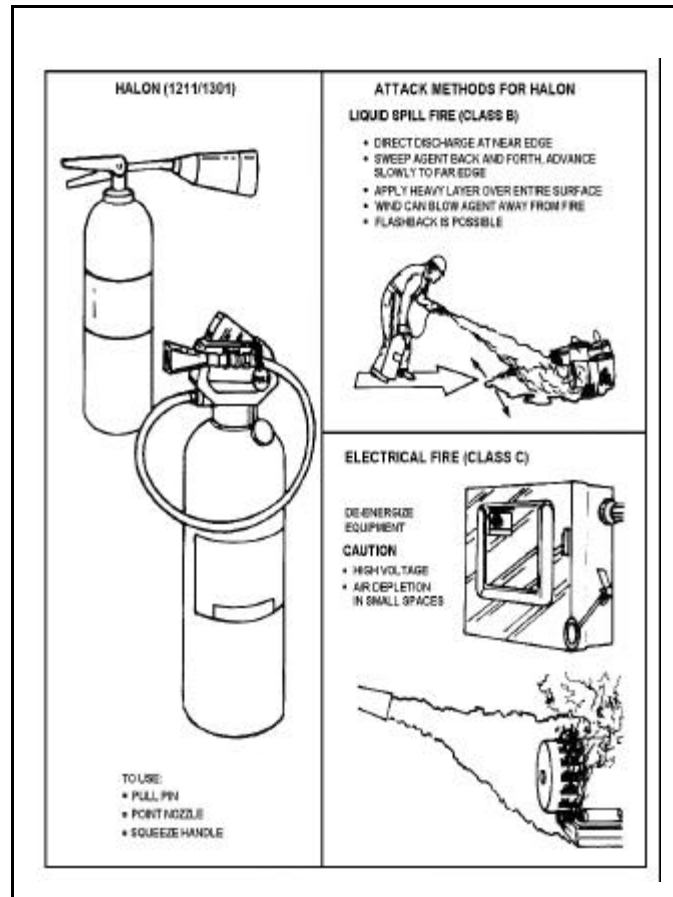

Figure 11-24. Operation of Halon Extinguishers

PURPLE-K EXTINGUISHER

11-116. PKP extinguishers are dry chemical extinguishers, provided primarily for use on Class B fires. PKP is nontoxic and is four times as effective as CO₂ for extinguishing fuel fires. PKP is effective on Class C fires, but do not use if CO₂ is available. Also, do not use on internal fires in gas turbines or jet engines because it leaves a residue that cannot be completely removed without disassembly of the engine.

11-117. The PKP extinguisher weighs about 18 pounds and uses CO₂ as the expellant gas. The extinguisher shell is not pressurized until it is to be used. Maximum range of the extinguisher is 20 feet from the nozzle and expellant will last for 18 to 20 seconds. Operating procedures (see also Figure 11-25) are as follows:

- Pull the locking pin from the seal cutter assembly.

- Sharply strike the puncture lever to cut the gas cartridge seal. The extinguisher is now charged and ready for use.
- Discharge the chemical in short bursts by squeezing the grip of the nozzle. Aim the discharge at the base of the flames and sweep it rapidly from side to side. If the fire's heat is intense, a short burst of powder into the air will provide a heat shield.
- When finished, invert the cylinder, squeeze the discharge lever, and tap the nozzle on the deck. This will release all the pressure and clear the hose and nozzle of powder. If not cleared, the PKP could cake and cause difficulty the next time the extinguisher is used.

11-118. PKP is an excellent fire-fighting agent, but its effects are temporary. It has no cooling effect and provides no protection against reflash of the fire. Therefore, it should always be backed up by foam. Use PKP sparingly in confined spaces, consistent with extinguishing the fire. An unnecessarily long discharge reduces visibility, makes breathing difficult, and causes coughing.

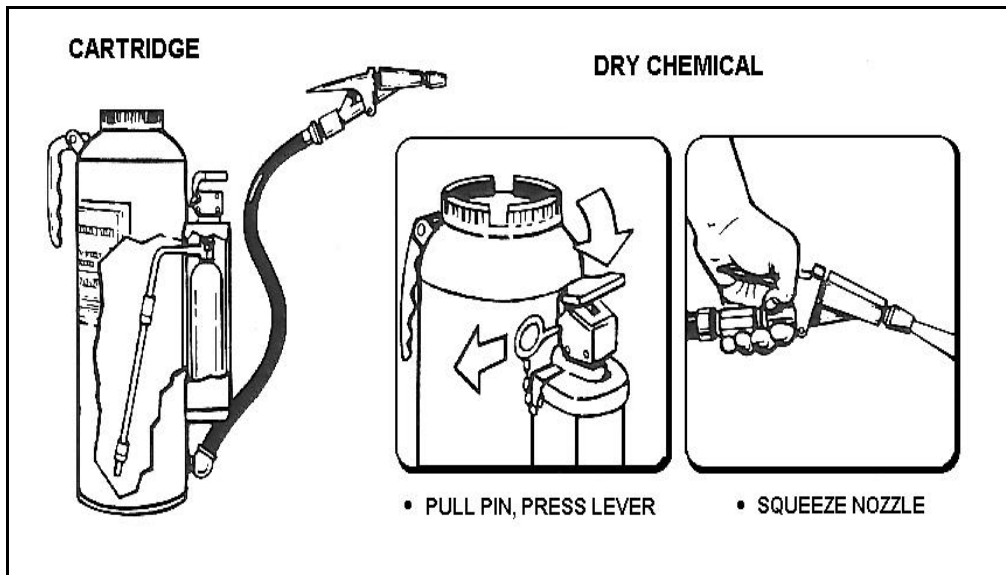

Figure 11-25. Operation of the PKP Extinguisher

PORTABLE FOAM SYSTEMS

11-119. A foam system using an in-line proportioner or a mechanical foam nozzle (with pickup tube) can be carried to various parts of the ship. The foam system is used with the ship's fire-main system. It is an efficient method for producing foam, but it requires more manpower than semiportable systems employing other extinguishing agents.

Mechanical Foam Nozzle With Pickup Tube

11-120. When using, attach the mechanical foam nozzle with pickup tube to a standard hose line from the fire-main system. It draws air in through an aspirating cage in its hose line end. At the same time it introduces mechanical foam concentrate into the water stream through a pickup tube. When the air and foam solution mix, foam is discharged from the nozzle.

11-121. One type of nozzle consists of a 21-inch length of flexible metal hose or asbestos-composition hose, 2 inches in diameter, with a solid metal outlet. A suction chamber and an air port in the hose line end form the aspirating cage. The pickup tube is a short piece of 5/8-inch metal pipe with a short piece of rubber hose on one end. It is used to draw up the contents of a 5-gallon container of foam concentrate. The pickup tube operates on suction created in the suction chamber of the nozzle.

Operation

11-122. The mechanical foam nozzle is screwed onto the fire hose and the pickup tube is screwed into the side port in the base of the nozzle. The metal pipe at the end of the pickup tube is inserted into the foam-concentrate container. When water pressure is applied to the hose, foam concentrate is drawn up to the nozzle where it mixes with the air and water. The resulting foam is applied in the usual manner. The mobility of the foam nozzle is improved if one fire fighter operates the nozzle while another follows with the concentrate container (see also Figure 11-26).

PORTABLE PUMPS

11-123. Portable pumps are a valuable adjunct to the installed pumps of a vessel. They may be used for fighting fires and for removing water from the ship (dewatering).

11-124. The P-250 pump (Figure 11-27) is a self-priming, 250 GPM, portable pump with a 2-cylinder, 2 cycle, 25-horsepower engine. Lubricate the pump by mixing 1/2 pint of 3064 (SAE 30) TEP oil to a gallon of 80- to 100-octane gasoline. Engine cooling is accomplished by pump discharge water passing through the engine.

11-125. This pump is designed for fire fighting and dewatering. The pump is equipped with a 3-inch male intake to which is fitted a 3-inch hard rubber suction hose (10 or 20 feet long) with a foot valve strainer. The discharge outlet is fitted with a 2 1/2-inch male thread to which a 2 1/2-inch hose or a trigate valve is attached. The trigate valve is equipped with a 1 1/2- to 2 1/2-inch thread reducer, making it possible to attach three 1 1/2-inch hoses or one 2 1/2-inch hose. With the reducer removed, a single 2 1/2-inch hose can be used for fire fighting or as the pressure hose for an eductor. The exhaust hose is a 2-inch hard rubber hose.

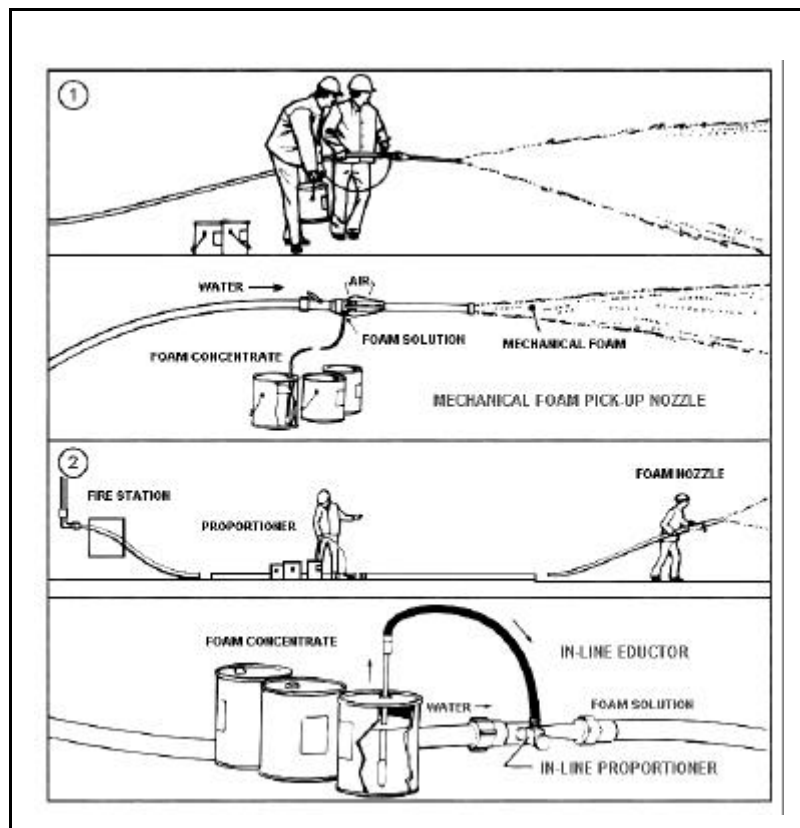
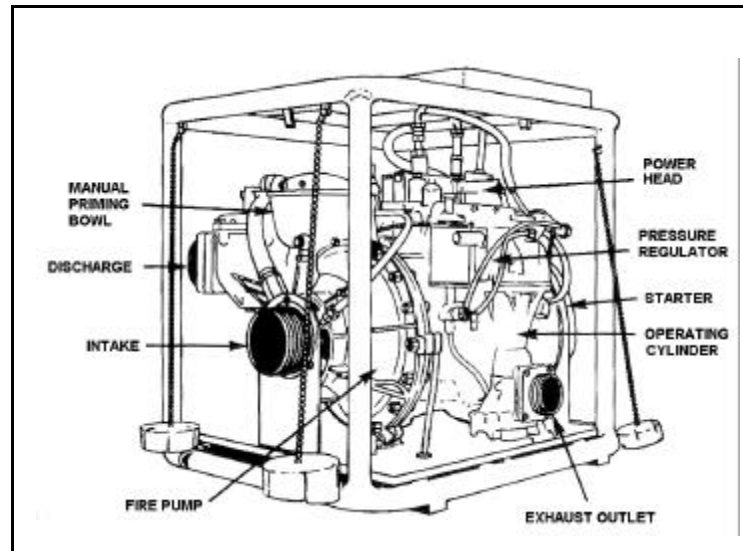

Figure 11-26. Using the Mechanical Foam Pick-Up Nozzle

Figure 11-27. P-250 Pump



11-126. With the foot valve on the suction hose, the P-250 is self-primed by a special primer pump connected to the intake side of the fire pump. However, when the eductor is used or when the lift is greater than 16 to 20 feet, the fire pump must be primed by hand.

11-127. Depending on the amount of water used, delivery pressure may be adjusted within a range of 80 psi to 120 psi. Volume, of course, depends on the number and size of the nozzles.

11-128. Before securing, the portable pump should be flushed out with clean, fresh water. This is to remove salt and any other residue buildup, which may cause the pump to seize.

11-129. The following are the starting procedures for the P-250 pump:

- Remove the thread protector caps. There are three of them (discharge outlet, intake outlet, and exhaust outlet).
- Attach the suction hose to the intake outlet.
- Attach the “foot” to the other end of the suction hose.
- Put the “foot” end of the suction hose into the water.
- Attach the exhaust hose.
- Attach the discharge hose.
- If the suction lift is over 20 feet, unscrew and remove the cap to the manual priming bowl.

Note: If the suction lift is less than 20 feet, skip the next two steps and then continue.

- Fill the priming bowl with water.
- When the pump and priming bowl are full of water, replace the inlet cap on the priming bowl.

- Turn the OFF-START-RUN switch to the START position.
- Turn the speed control switch slightly in a clockwise direction.

Note: If the engine is cold, slightly turn the choke control in a clockwise direction.

- Push down on the START button when the engine is warm.

Note: If the starter engages, hold the START button down until the engine starts. If the starter does not engage, start the engine manually by pulling on the starter rope.

- Place the valve on the water discharge outlet to the OPEN position. If the pump has been manually primed, skip the next three steps and continue.
- If the pump has not been manually primed, make sure that the valve on the water discharge is in the CLOSED position.

- Push down, and hold down the primer push button until the water is discharged from the primer pump.
- Turn the valve on the water discharge to the OPEN position.
- When the pressure gauge reads 10 psi, release the primer button if you are holding it down.
- Turn the OFF-START-RUN switch to the RUN position.
- Turn off the choke if it was used.

SEMIPORTABLE FIRE EXTINGUISHERS

11-130. A semiportable extinguisher is one way a hose can be run out to the fire. The other parts of the system are fixed in place, usually because they are too heavy to move.

11-131. The semiportable Halon Hose-Reel System (Figure 11-28) is very similar to the carbon dioxide system. This is used to combat Class B and Class C fires. Most semiportable systems use Halon 1301. The system consists of one or two pressurized cylinders containing the extinguishing agent, a hose line, and a nozzle with an ON-OFF control valve. The system is activated by operating a release mechanism at the top of the cylinder, similar to the CO₂ release device. If two cylinders are used, they are both opened when the pilot cylinder is activated. When the agent is released, it travels through the hose up to the nozzle. The hose is then run out to the fire, and the agent is applied as required.

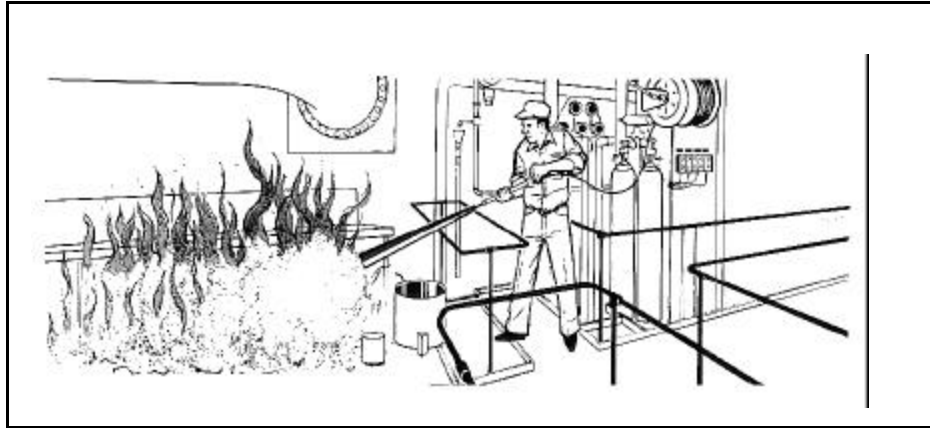

Figure 11-28. Operation of the Halon Hose-Reel System

FIXED FIRE STATIONS

11-132. The purpose of the fire-main system is to deliver water to the fire stations that are located throughout the ship. A fire station consists basically of a fire hydrant (water outlet) with valve and associated hose and nozzles. All required fire-fighting equipment must be kept in its proper place. Fire stations and hoses must be highly visible and easily put into service.

11-133. Crew members should try to protect all parts of the fire-main system and avoid unauthorized use of the system. Weekly visual inspection of fire stations should be a standard procedure to make sure that all required equipment is in its proper place. Hydrants located on weather decks may become corroded or encrusted with salt, causing their valves to freeze in position and become inoperable.

11-134. Different hydrants should be opened during succeeding weekly fire drills to make sure that water flows from each hydrant at least once every 2 months. This will reduce crusting and rust. When possible, flush out the fire-main system with fresh water to destroy any marine growth in the lines.

FIRE STATION LOCATIONS

11-135. Fire stations are located to ensure that the water streams from at least two hydrants will overlap. Fire hydrants shall be sufficient in number and so located that any part of the vessel, other than main machinery spaces, is accessible to persons onboard while the vessel is being navigated, and all cargo holds may be reached with at least two streams of water from separate outlets. At least one of these streams shall be from a single length of hose.

11-136. In main machinery spaces, all portions of such spaces will be capable of being reached by at least two streams of water, each of which shall be from a single length of hose and from separate outlets.

11-137. Fire stations are numbered. The term "Fire Station" and its number will be stenciled on the bulkhead in numerals at least 2 inches high.

HYDRANTS

11-138. The fire station hydrant has three major components: a control valve, the hose connection (1 1/2- or 2 1/2-inch) with appropriate threads, and a hose rack (Figure 11-29). Regulations require the following:

- Each fire hydrant outlet must have a valve that allows the hose to be removed while there is pressure in the fire-main system.
- The fire hydrant outlet may be in any position, from horizontal to pointing vertically downward. It should be positioned to lessen the kinking of the fire hose.
- The threads on the fire hydrant outlet must be National Standard fire hose coupling threads. These standard threads allow all approved hoses to be attached to the hydrant.
- A rack must be provided for the proper stowage of the fire hose. The hose must be stowed in the open or where it is readily visible.

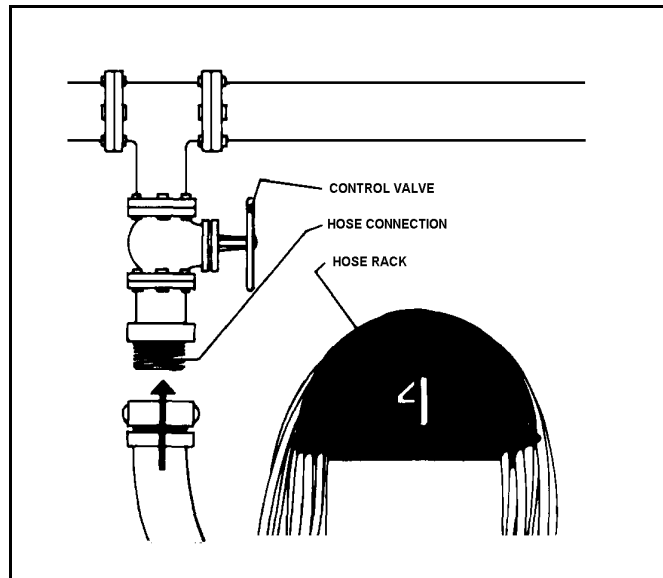

Figure 11-29. Three Components Of a Fire Station Hydrant

FIRE HOSES, NOZZLES, AND APPLIANCES

11-139. The efficiency of a fire station depends largely on the equipment stowed at the station and its condition. A single station should have the following equipment (see also Figure 11-30, page 11-46).

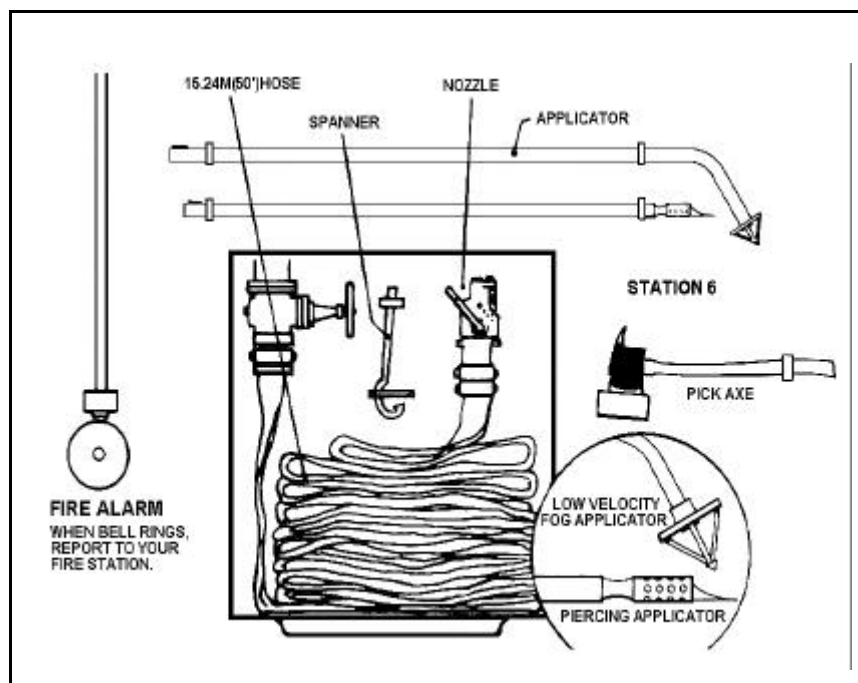

Figure 11-30. Shipboard Fire Station Equipment

Hoses

11-140. A single length of hose of the required size, type, and length is used. Use 2 1/2-inch diameter hose at weather deck locations and 1 1/2-inch diameter hose in enclosed areas. DO NOT use unlined hoses in machinery spaces. The hose couplings must be of brass, bronze, or a similar metal and be threaded with National Standard fire hose coupling threads. The hose must be 50 feet in length.

11-141. The fire hose with the nozzle attached must be connected to the hydrant at all times. However, when a hose is exposed to heavy weather on an open deck, it may be temporarily removed from the hydrant and stowed in a nearby accessible location. Temporarily move the fire hose if there is a possibility that it might be damaged during the handling of cargo. When the fire hose is removed, cover the exposed threads of the hydrant with a thin coating of grease and a protective screw cap. If a screw cap is not available, a heavy canvas, lashed over the threads, gives some protection.

Note: The fire hose may not be used for any purpose other than fire fighting, testing, and fire drills.

Racking and Stowing Hoses

11-142. Most shipboard racks for stowing hoses at fire stations require that the hose be faked. The procedure should include the following steps:

- Check the hose to make sure it is completely drained. A wet hose should not be racked.
- Check the female coupling for its gasket.
- Hook the female coupling to the male outlet of the hydrant. (The hose should always be connected to the hydrant.)
- Fake the hose so that the nozzle end can be run out to the fire.
- Attach the nozzle to the male end of the hose, making sure a gasket is in place.
- Place the nozzle in its holder or lay it on the hose so that it will not come adrift.

11-143. There are several different types of hose racks. One type consists of a half round plate, over which the hose is faked. A horizontal bar swings into position, holding the hose snug. Reels are used in engine rooms. They are also used for rubber hoses, such as those that are found on a semiportable CO₂ extinguisher.

Rolling Hose

11-144. After using the spare hose, it should be rolled and replaced in stowage. The hose must first be drained and dried. It should then be placed flat on the deck with the female coupling against the deck. The hose is next folded back on itself, so the male coupling is brought up to about 4 feet from the female coupling. The exposed thread of the male coupling should be layered between the hose when the roll is completed. Tie the roll with small stuff to keep it from losing its shape.

Nozzles and Applicators

11-145. Combination nozzles are quite rugged, but are still subject to damage. For example, the control handle can become stuck in the closed position, due to the corrosive action of seawater. Combination nozzles and applicators are often clogged by small pieces of dirt that enter and collect around openings. Periodic testing and maintenance will help detect and correct deficiencies.

11-146. The combination nozzle has a spring latch that allows the high-velocity tip to be released. The latch often freezes into position from misuse. During inspections and drills, the tip should be released and the applicator inserted into position for proper operation. The high-velocity tip should be attached to the nozzle by a substantial chain, so that it cannot be completely separated from the nozzle (see Figure 11-31, page 11-48).

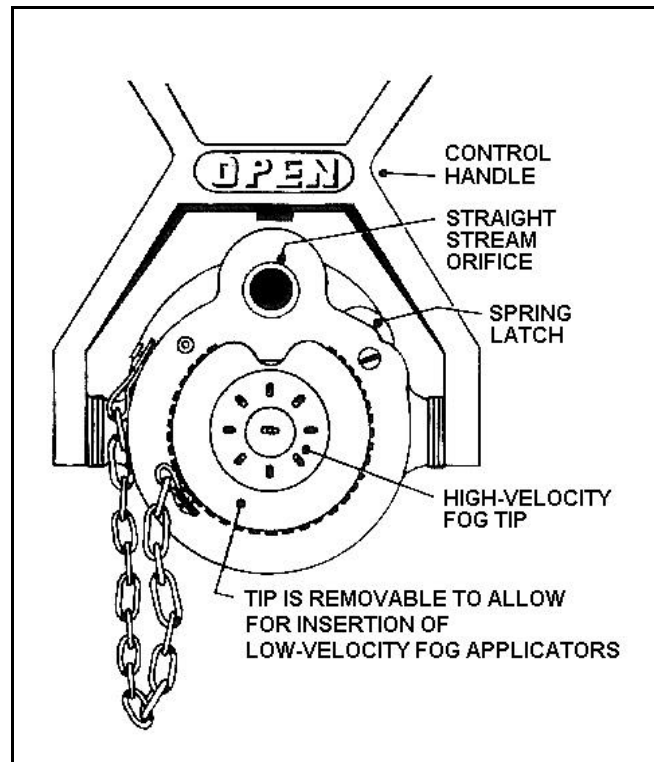

Figure 11-31. Outlet End of Combination Nozzle

11-147. Applicators are strong, but not strong enough to be used as crowbars, levers, or supports for lashing. If misused, the applicator can be crimped or bent along its length. The bayonet end can be damaged so that it cannot fit in the nozzle receptacle. Stow applicators in the proper clips at the fire station. Use applicators for fire fighting and training only. When stowed, applicator heads should be enclosed in sock-type covers to keep foreign matter out.

Appliances

11-148. A spanner wrench (Figure 11-32) is a special tool designed specifically for tightening or breaking apart fire-hose connections. The spanner should match the hose size and butt configuration. Hose-butt lug designs change over the years, making some spanner wrenches obsolete. When new hose is ordered, the available spanner wrenches must be compatible with the new hose couplings, or new spanner wrenches must also be ordered.

Note: Most hose connections can be made hand-tight and do not require excessive force.

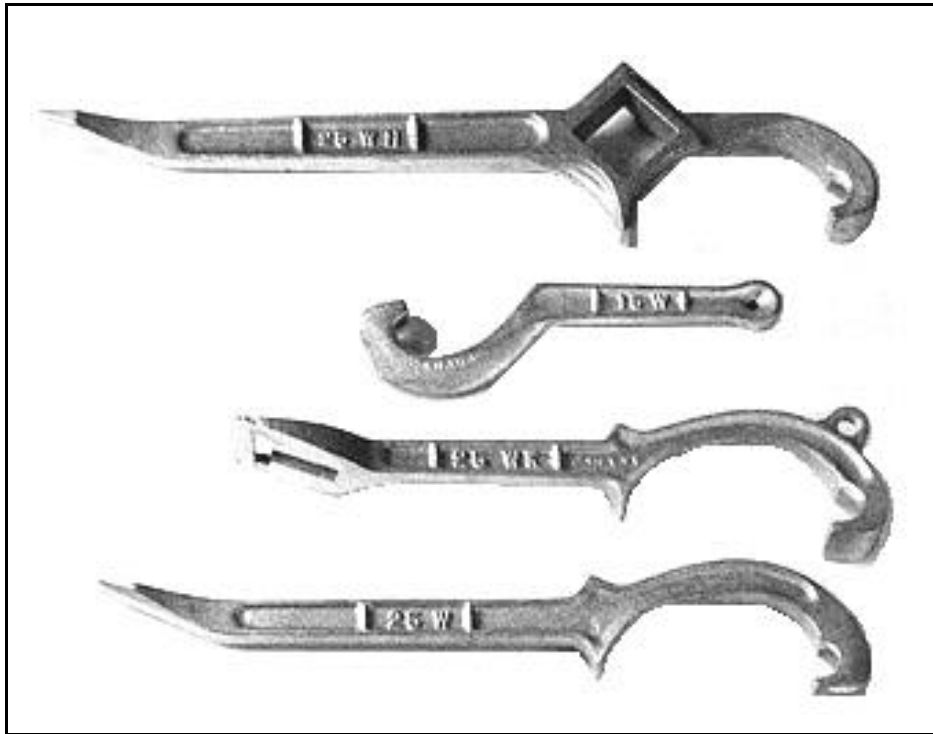

Figure 11-32. Spanner Wrenches

11-149. The pike head fire axe (Figure 11-33, page 11-50) is a multipurpose, portable, fire-fighting tool. The pike (pointed) end of the axe may easily be driven through light metal, including metal clad fire doors and some Class C bulkheads. It can be used to make openings quickly and to check for smoke or fire extension. It is also useful for tearing apart mattresses and upholstered furniture and for shattering heavy glass (including tempered glass) when necessary. The broad end of the axe can be used to pry open hinged doors, to remove paneling and sheathing to expose recesses and voids (avenues of fire travel), or to chock doors open.

11-150. Crew members must be cautious when using axes to force a door or break glass. They should wear gloves and other protective clothing, if available. A door should be forced only when necessary. The door should first be checked to see if it is unlocked. If locked, there may be time to obtain a key (especially if the fire is a minor one and lives are not in danger). Otherwise, if a door must be forced, it must be done without hesitation.

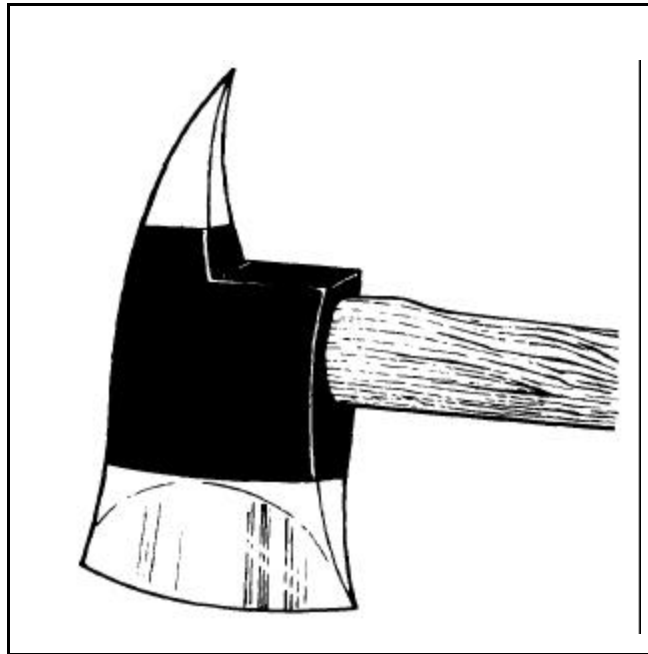

Figure 11-33. Pike Head Fire Axe

11-151. Inspect axes periodically. They should be sharpened, cleaned, or repaired as necessary. The blade and pike ends should be kept sharp and free of burrs. The handle should be tight in the axe head and free of splits and splinters. An occasional light oiling will keep the head from rusting.

SELF-CONTAINED BREATHING APPARATUS

11-152. Although the air encountered at a fire is hot, contaminated by smoke and toxic gases, and deficient in oxygen, crewmen must enter this hostile environment to fight the fire. Their problem is simple, direct, and urgent--they must breathe. The equipment discussed in this paragraph is designed to enable seamen to enter such a hostile environment with some degree of protection for the respiratory system.

11-153. A breathing apparatus is a device that provides the user with breathing protection. It includes a facepiece, body harness, and equipment that supplies air or oxygen. Breathing apparatuses are available in several types. Each type is effective, if used properly. Each one has certain advantages and disadvantages.

THE DEMAND UNIT

11-154. This type will provide air or oxygen from a supply carried by the user. Use the OBA in any atmosphere that contains, has contained, or is suspected of containing flammable or combustible liquids or gases. Never wear the OBA in a cofferdam or any compartment fouled by fuel oil.

THE STANDARD FACEPIECE

11-155. The facepiece is an assembly that fits onto the face of the person using the breathing apparatus. The facepiece forms a tight seal to the face and transmits air or oxygen to the user. The standard facepieces (Figure 11-34 and Figure 11-35) are shown with the breathing apparatus covered in this paragraph.

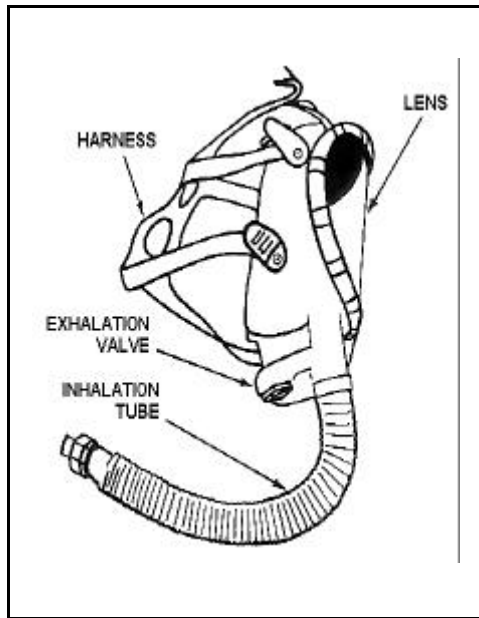

Figure 11-34. Single Hose Facepiece

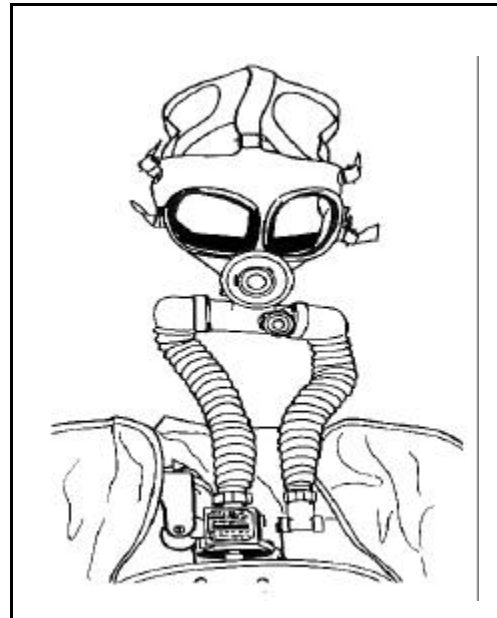

Figure 11-35. Dual Hose Facepiece

Construction

11-156. The basic part of the facepiece is the mask. It is made of oil-resistant rubber, silicone, neoprene, or plastic resin. Most facepieces include a head harness with five or six adjustable straps, a flexible inhalation tube, an exhalation valve, and a wide-view lens. Some models also include a nose cup or a speaking diaphragm. The facepiece used with oxygen-generating equipment has an exhalation tube and an inhalation tube. Each tube has a mica disk-type valve for airflow control.

- **Head harness.** The head harness holds the facepiece in the proper position on the face, with just enough pressure to prevent leakage around the edge of the mask. Before stowing the facepiece, be sure all harness straps are fully extended, with the tab ends against the buckles. This helps ensure that the facepiece can be donned quickly in an emergency.
- **Exhalation valve.** The exhalation valve on a single hose facepiece (Figure 11-34) is a simple one-way valve. It consists of a thin disk of rubber, neoprene, or plastic resin, secured in the center of the facepiece. It may be contained in a hard plastic mount located at the front of the chin area. The exhalation valve, commonly referred to as the “flutter valve,” releases exhaled breath from the facepiece.
- **Flexible tubes.** The flexible inhalation tube carries fresh air or oxygen to the facepiece. In the facepiece with dual hoses (Figure 11-35), the exhalation tube returns exhaled breath from the facepiece to the canister. The inhalation and exhalation valves controls airflow through these tubes. Like the facepiece, the flexible tubes are made of oil-resistant rubber, neoprene, or plastic resin. In use, the tubes must be kept free and unkninked for the proper flow of air. Avoid all unnecessary strain on these tubes. If they become tangled in any way, they must be freed carefully. DO NOT pull them free.
- **Lens.** The facepiece may be supplied with dual lenses or a full-view single lens. In some cases, the single lens is available as an optional item at additional cost. The lens gives the wearer a wide range of vision. It is made of a plastic base resin and is attached to the mask with a removable frame or metal ring. Protect, as much as possible, the lens from scratches when in use or during handling and packing.
- **Nose cup.** The nose cup is an optional removable piece that fits into the exhalation valve. It is designed to reduce fogging of the lens.
- **Speaking diaphragm.** The speaking diaphragm projects the wearer’s voice from the facepiece with little or no distortion. It is located directly in front of the wearer’s mouth and is similar in appearance to the exhalation valve.
- **Pressure relief valve.** The facepieces used with canister- and cylinder-type breathing apparatus include a combination pressure relief and saliva valve. The valve is located in the cross-tube that connects the inhalation and exhalation tubes. It automatically relieves pressure within the facepiece. The wearer may also use the valve to get rid of saliva and to exhaust exhaled air to the outside by pressing a spring-loaded button.

Use and Maintenance

11-157. Donning, stowing, and maintaining the facepiece all affect its efficiency in use. For example, poorly stowed equipment is difficult to put on. Poorly maintained equipment could cause difficulties in achieving an uncontaminated atmosphere within the facepiece. Poorly donned equipment will simply not effectively protect the wearer.

Putting on the Facepiece

11-158. When the facepiece is put on properly, the chin straps are below the ears. The harness pad is at the back of the head, as close to the neck as possible. The side straps are above the ears. The mask portion is snug, but not tight. Two factors are important when the facepiece is to be put on.

- First, the wearer must obtain the proper seal by adjusting the harness.
- Second, time is precious when the breathing apparatus is needed; every second counts.

11-159. After much testing, the following method has proved to be the most effective for five-strap and six-strap facepieces. For the facepiece to be donned as recommended, the harness must be fully extended and pulled over the front of the lens. The tab end of each strap must be up against the buckle. If this was not done when the facepiece was stowed, it must precede the first step of the following donning procedure (see also Figure 11-36, page 11-54).

- **Step 1.** Hold the facepiece at the bottom with one hand. Place your chin in the pocket at the bottom of the mask, and fit the mask to your face.
- **Step 2.** Put your other hand between the mask and the harness. Your palm should be on the lens, and your fingers and thumb should be fully extended and spread.
- **Step 3.** In one smooth motion, push the harness over the top of your head. Push with the back of your hand and your fingers. Keep your fingers spread and extended as the harness slips into place.
- **Step 4.** Tighten the chin straps by gently pulling them out and back. This places the harness pad at the back of the head close to the neck. For the proper fit and seal, tighten the straps from the bottom up.
- **Step 5.** Tighten the side straps as described in step 4.
- **Step 6.** Tighten the top straps last, again as described in step 4. When steps 4, 5, and 6 are completed in the proper order, the harness should fit tightly against the back of the head.
- **Step 7.** Test the facepiece for leakage as follows:

- For demand-type breathing apparatus, block the end of the inhalation tube with the palm of your hand while trying to inhale. If the facepiece is properly fitted, it will collapse against your face.
- For oxygen-generating or oxygen-rebreathing equipment, grasp both tubes while trying to inhale. Again, a properly fitted facepiece will collapse against your face.



Figure 11-36. Steps for Putting on the Facepiece

SELF-GENERATING (CANISTER) TYPE OBA

11-160. The self-generating, or canister, type OBA (Figure 11-37) is also a self-contained breathing apparatus. In this unit, the wearer's exhaled breath reacts with chemicals in a canister to produce oxygen. The wearer then breathes this oxygen.

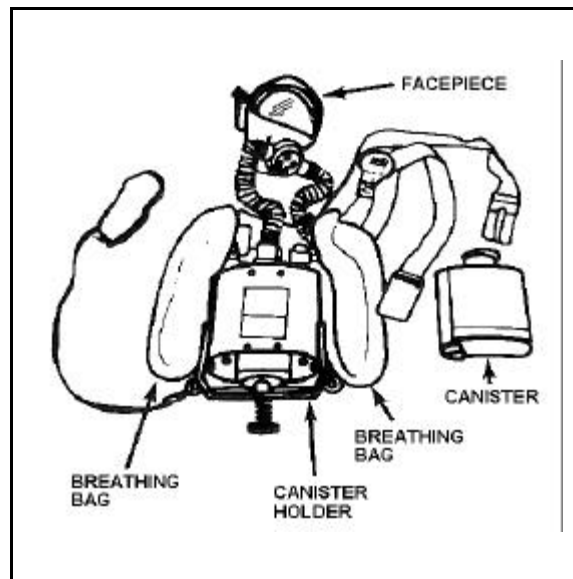

Figure 11-37. Canister Type OBA

Construction

11-161. The canister-type unit consists basically of five parts:

- Facepiece with an inhalation tube, an exhalation tube, and a pressure relief valve.
- Breathing bag.
- Canister holder and canister.
- Manual timer.
- Breastplate with attached body harness.

11-162. Store the unit in a suitcase-type container with room for three canisters. Complete operating instructions are displayed inside the cover of the case.

11-163. The canister contains chemicals that react with moisture in the wearer's exhaled breath to produce oxygen. These chemicals also absorb carbon dioxide from the exhaled breath. If the unit is used for a short time and then removed, a new canister must be inserted before the next use. The chemicals in the canister continue to react even after the facepiece is removed and there is no accurate way of measuring the time left before the chemicals are used up. The breathing bag holds and cools the oxygen supplied by the canister and is made of reinforced neoprene.

11-164. The manual timer is set when the equipment is put into operation. It gives an audible alarm to warn the operator when the canister is nearly expended. The timer is no more than a clock; it does not indicate the condition of the canister. It should always be set to allow the wearer enough time to leave the contaminated area after the alarm sounds.

11-165. The body harness is a series of web straps that position and stabilize the apparatus. The breastplate holds the canister and protects the wearer from the heat generated by the unit.

Operating Cycle

11-166. Figure 11-38 shows the operating cycle of the canister-type unit. The wearer's exhaled breath [1] passes from the facepiece into the exhalation tube and then into the canister. The chemicals in the canister absorb moisture and carbon dioxide [2]. They produce oxygen, which passes from the canister to the breathing bag [3]. When the wearer inhales [4], the oxygen moves from the breathing bag to the facepiece [5] via the inhalation tube.

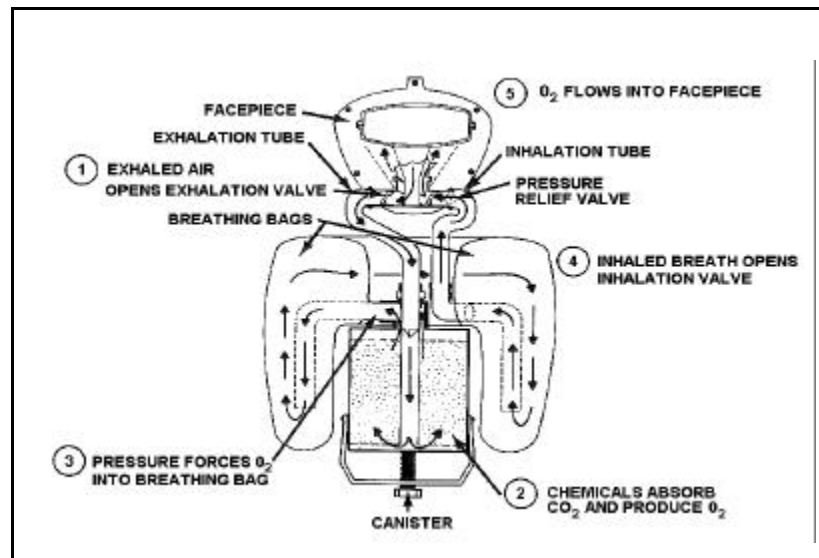

Figure 11-38. Sequence of Operating Cycle for OBA

Putting on the OBA

11-167. You can, without too much trouble, put on the OBA without assistance. Do the following steps to put on the OBA.

- **Step 1.** Grasp one shoulder strap in each hand and lift the harness over your head. This allows the equipment to rest on your chest while it is supported by the shoulder straps (Figure 11-39, page 11-58).
- **Step 2.** Reach around back to locate the side straps. Attach the side straps, one at a time, to the D-rings on the breastplate with the hooks provided. Then tighten the harness so it fits securely and comfortably (Figure 11-40, page 11-58).
- **Step 3.** Put the waist strap around your neck, attach the hooks at the D-ring, and tighten the strap (Figure 11-41, page 11-59).
- **Step 4.** Remove a canister from the carrying case. There are two types of canisters: self-start and manual-start (Figure 11-42, page 11-59). Steps 9 and 10 describe how to start each type of canister you are using.

Note: The self-start canister has a small metal box at the bottom.

- **Step 5.** Remove the protective cap from the top to expose a thin copper seal (Figure 11-43, page 11-59).
- **Step 6.** Swing the canister retaining bail forward and hold it with one hand. Now insert the canister in the holder, with the label facing outward, away from your body (Figure 11-44, page 11-59).
- **Step 7.** Swing the retaining bail down under the canister and tighten the retainer (a heavy screw with a pad and hand-wheel) by turning it clockwise. This secures the canister in the holder and forms a seal between the canister and the central casting. The point of the central casting punctures the copper seal (Figure 11-45, page 11-60).
- **Step 8.** Check the canister type to determine the correct starting action. Then don the facepiece as described in paragraph 11-158.
- **Step 9.** Start a self-start canister as follows. Locate the small triangular metal tab on the metal box at the bottom of the canister. Grasp the tab with the thumb and index finger of your right hand and pull it downward (Figure 11-46, page 11-60). The small metal box will come away from the canister, exposing a lanyard. Grasp the lanyard with your index finger and thumb and pull it straight out away from your body. Do not pull down on the lanyard. The correct action will activate the chemicals in the canister, filling the breathing bag with oxygen. If the lanyard breaks and does not activate the self-starter, use the manual-start procedure in step 10.

- **Step 10.** Start a manual-start canister in a safe, uncontaminated area by inserting one or two fingers under the facepiece and stretching it away from your face (Figure 11-47, page 11-60). With the other hand, grasp the inhalation and exhalation tubes and squeeze them tightly; then inhale. Now release the tubes, remove your fingers from under the mask, and exhale. Repeat this procedure several times to inflate the breathing bag. This will start the chemical action in the canister. Do not overinflate the breathing bag! It should be firm, but not rock hard.
- **Step 11.** Test the facepiece for leakage by squeezing the inhalation and exhalation tubes while inhaling (Figure 11-47, page 11-60). If the facepiece is properly fitted, it will collapse against your face.
- **Step 12.** Set the timer (Figure 11-48, page 11-60) by turning the knob clockwise. On older units, the timer is set for 30 minutes. This allows the wearer 15 minutes to leave the contaminated area after the alarm sounds. On newer units, the timer may be set for 45 minutes or less. The control should be turned to the extreme clockwise position and then reset to the desired time interval. This ensures that the alarm will sound for a full 8 to 10 seconds.



Figure 11-39. Putting on the OBA, Step 1

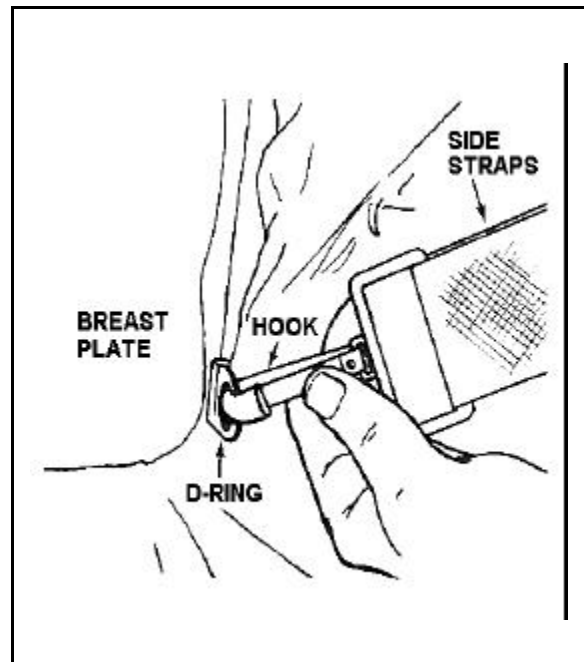

Figure 11-40. Putting on the OBA, Step 2

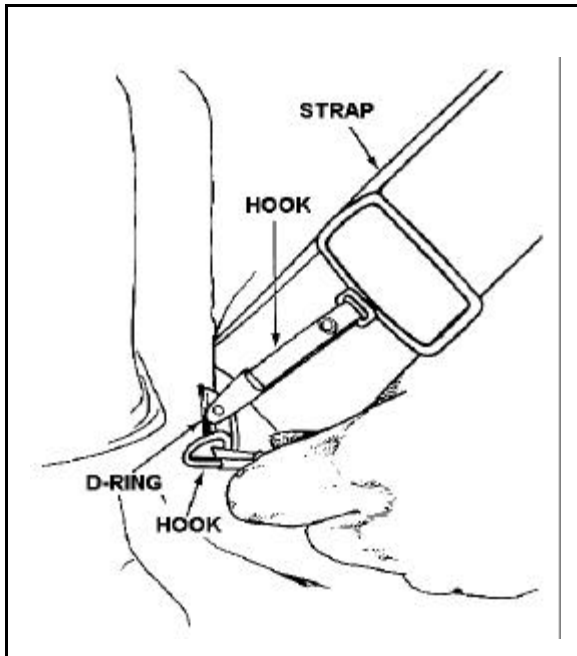

Figure 11-41. Putting on the OBA, Step 3

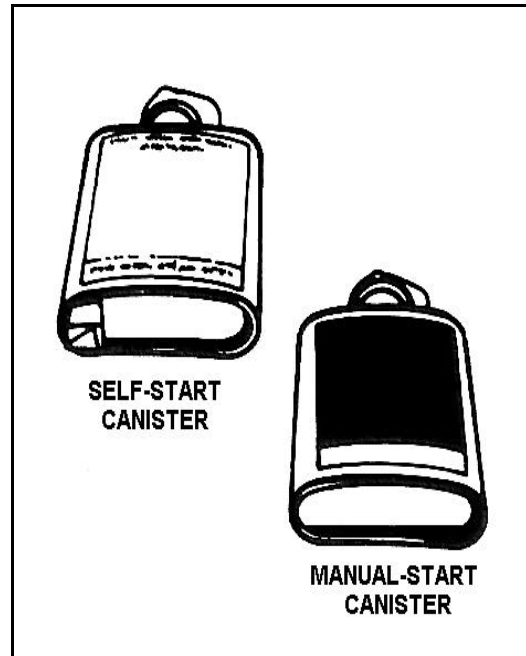

Figure 11-42. Putting on the OBA, Step 4

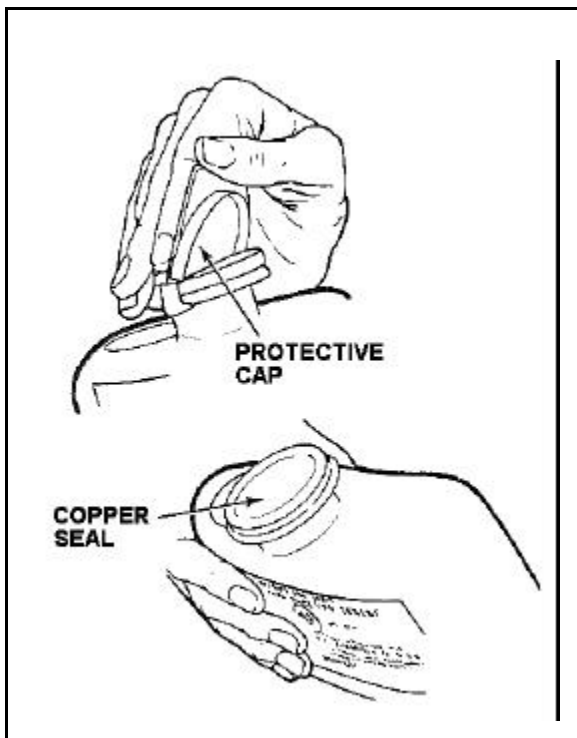

Figure 11-43. Putting on the OBA,

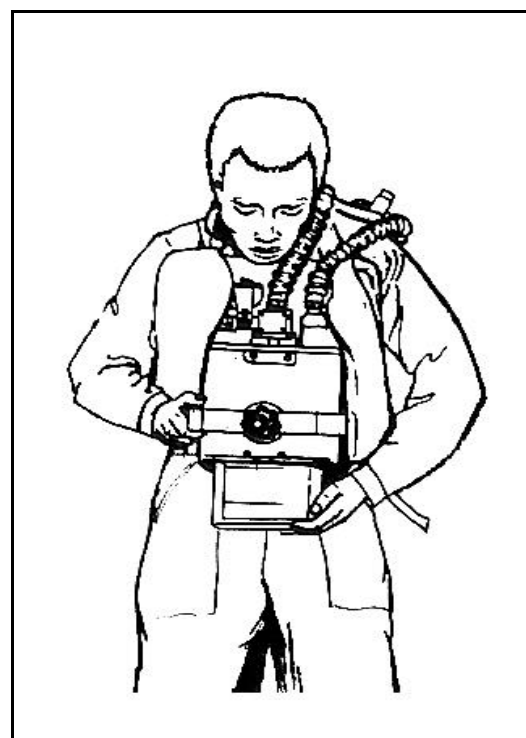

Figure 11-44. Putting on the OBA, Step 6

Step 5

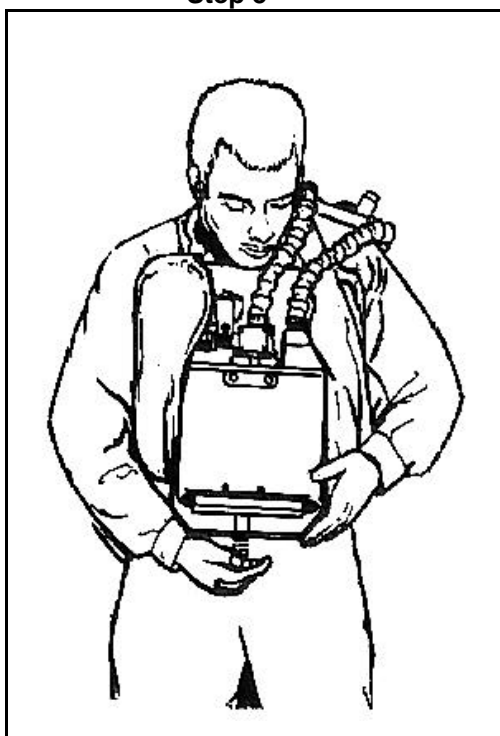

Figure 11-45. Putting on the OBA, Step 7

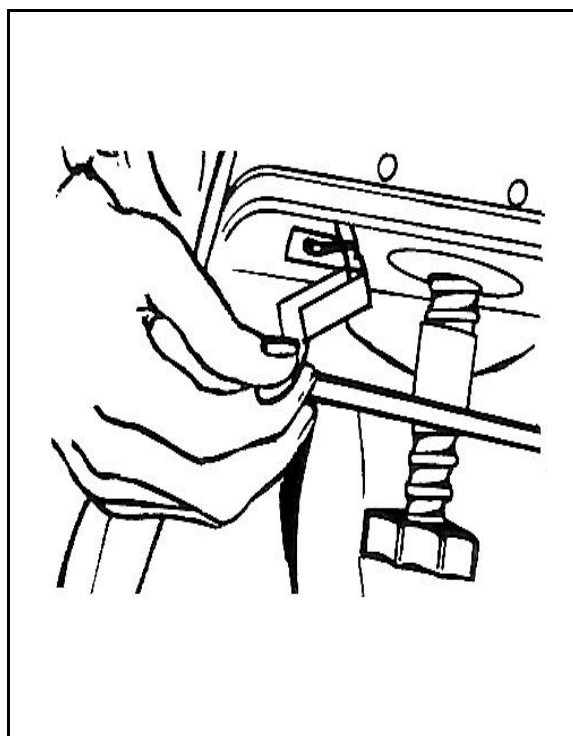

Figure 11-46. Putting on the OBA, Step 9

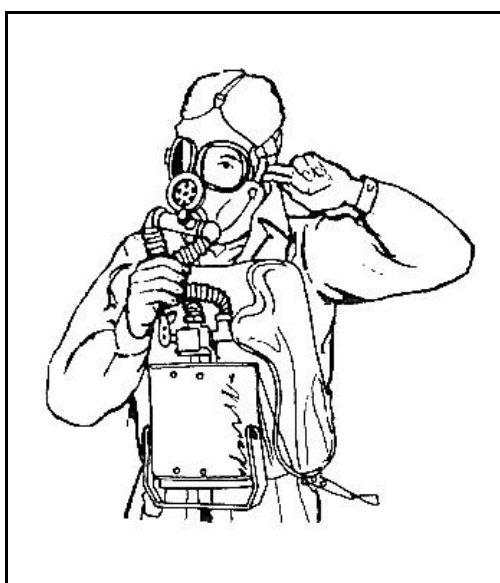

Figure 11-47. Putting on the OBA, Steps 10 and 11

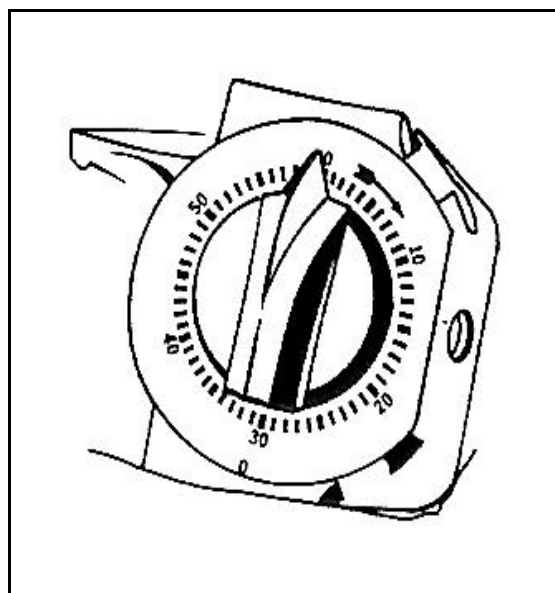

Figure 11-48. Putting on the OBA, Step 12

CAUTION: If the lenses fog up, any part of the unit malfunctions, or the wearer experiences any discomfort or difficulty in breathing, he must immediately retreat to safety. One cause of difficulty in breathing is an overinflated breathing bag. If the bag is overinflated, it will seem very hard. This problem can be corrected, in a safe area, by briefly depressing the button in the center of the relief valve. The bag should not be allowed to deflate completely during this process. If the bag becomes underinflated, the user must repeat step 10.

Removing the Canister

11-168. The removal and disposal of an expended canister are very hazardous operations that must be performed to avoid injury. The procedure (see also Figure 11-49, page 11-62) is as follows:

- **Step 1.** Spread your feet wide apart, and lean forward from the waist. (The chemical action that takes place in the canister generates sufficient heat to burn bare skin. For this reason, you must not touch the expended canister.)
- **Step 2.** Loosen the retaining screw by turning the handwheel counterclockwise.
- **Step 3.** Swing the retaining bail forward, and let the canister drop to the deck. It must not be tossed (or allowed to fall) into the bilge, or any place where oil, water, snow, ice, grease, or other contaminants can enter the hole in the copper seal. Organic material may cause a violent reaction. Water and substances containing water will cause a rapid chemical action in the canister, creating more pressure than can be released through the small neck opening. This pressure could cause an explosion that would produce flying fragments and injure anyone in the vicinity.
- **Step 4.** Puncture the expended canister several times, front and back, with the pike end of a fire axe (Figure 11-50, page 11-62).
- **Step 5.** Fill a pail with clean water, deep enough to completely submerge the canister. Gently drop the canister into the water. A violent chemical reaction will take place. However, the pressure cannot build up if the canister has been properly punctured, so there is no danger of an explosion.
- **Step 6.** After the boiling has stopped, the water (which is now caustic) and the canister must be discarded as a hazardous waste in accordance with unit, state, and federal regulations.



Figure 11-49. Removing the Canister

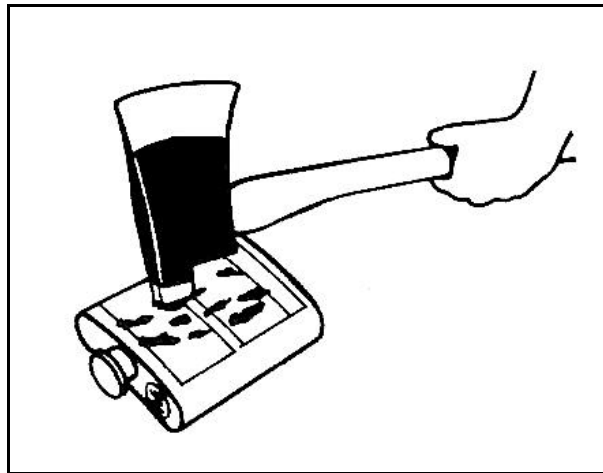

Figure 11-50. Puncturing the OBA Canister

Maintenance of Oxygen-Generating Apparatus

11-169. The oxygen-generating apparatus must be maintained carefully. The manufacturer or his representative must replace worn or damaged parts. Those who use the equipment should faithfully perform periodic inspections and after-use maintenance by using the following procedures:

- Clean the facepiece. Be especially careful to dry all the equipment thoroughly.
- Check the inhalation and exhalation valves periodically for corrosion and replace if necessary.
- Test the alarm bell to make sure it operates properly.
- Inspect the breathing bag for signs of damage and wear.

- Inspect the canister holder and retaining bail and screw for damage, wear, and proper operation. Check the central casting plunger that breaks the seal and seals the canister into the system. This plunger operates by moving in and out about one fourth of an inch. A spring holds the plunger out. When the canister is inserted and tightened down by the bail screw, the plunger is depressed against the spring. This action ensures a tight seal. If the plunger does not work properly, it must be repaired or replaced; it should never be lubricated.

Safety Precautions

11-170. Certain precautions must be taken when the oxygen-generating apparatus is used. The user must be careful not to damage the breathing bag on nails, broken glass, or other sharp objects. When it is necessary to operate the relief valve, he must do so carefully so as not to deflate the breathing bag too much.

11-171. The instructions on the canister must be followed. Foreign material, especially petroleum products, must be kept from entering an opened canister. The chemical in the canister must not come in contact with the skin.

11-172. The apparatus must not be stowed with a canister already inserted. After one use, regardless of how short, the canister must be discarded as described. For older units without the self-start action, three fresh canisters should always be kept in readiness, with their caps intact, in the storage case. For newer units with the self-start action, two fresh canisters may be kept in the case.

Advantages and Disadvantages of the OBA

11-173. The greatest advantage of the oxygen-generating apparatus is its staying time. The canister produces enough oxygen for comfortable breathing up to 45 minutes, and it is much lighter than other self-contained units. Therefore, it is advantageous for use in large contaminated spaces where ventilation may be difficult, where it is difficult to locate the fire or the source of contamination, and wherever an uninterrupted operating time of up to 45 minutes is needed.

11-174. The following are some disadvantages of the canister-type apparatus:

- About 2 minutes is required to start a manual-start canister and get the equipment into operation.
- If the relief valve is not operated properly, the breathing bag may lose its oxygen. The wearer must then return to an uncontaminated area to restart the unit.
- The bulkiness of the unit and its location on the wearer's chest may reduce maneuverability and the ability to work freely.

- The possibility of an explosion, because of the heat produced by the canister, if the canister is not properly disposed.
 - If unit is not used properly, an explosive reaction can occur when petroleum products are introduced into the canister opening.
 - The unit is not easily used for buddy breathing in rescue work.
-
- The apparatus cannot be used in an atmosphere that has contained or is suspected of containing flammable or combustible liquids or gases.
 - When the alarm bell sounds, it rings once and stops. Due to noise or some other distraction, the wearer may not hear the alarm.

SELF-CONTAINED, DEMAND-TYPE BREATHING APPARATUS

11-175. The demand-type breathing apparatus is being used increasingly aboard ships. Its popularity stems from its convenience, the cool fresh air it supplies the user, the speed with which it can be put into service, and its versatility. The demand-type apparatus gets its name from the functioning of the regulator, which controls the flow of air to the facepiece. The regulator supplies air "on demand;" that is, it supplies the user with air when he needs it and in the amount his respiratory system requires. It therefore supplies different users with air at different rates, depending on their "demand."

Note: The newer model of the demand-type breathing apparatus is being supplied with a positive flow to the facepiece. The slight pressure in the facepiece prevents contaminated air from entering the facepiece and getting into the respiratory tract. This positive air pressure lessens the critical nature of the facepiece fit against the user's face.

11-176. The self contained, demand-type apparatus consists of four assemblies:

- **Facepiece.** The facepiece used is the standard full-face type discussed earlier in this chapter.

- **Regulator.** Air from the supply cylinder passes through the high-pressure hose and a preset pressure-reducing valve in the regulator. The admission valve is normally closed. However, when the user inhales, he produces a partial vacuum on one side of the admission valve. This opens the valve, allowing air to pass into the facepiece. The amount of air supplied depends on the amount of vacuum produced, which in turn depends on the user's air requirements. The regulator has a low-pressure alarm bell attached to the high-pressure hose. Older models of this regulator were equipped with a reserve valve. The reserve-valve lever is placed in the "start" position when the equipment is donned. When the cylinder pressure falls to about 500 psi, breathing becomes difficult, and the wearer must move the reserve lever to the "Reserve" position. This allows the wearer 4 to 5 minutes of reserve air with which to leave the contaminated area. An alarm bell kit can be installed on this older regulator model.
- **Air cylinder.** The air cylinder includes a pressure gauge and a control valve. On most cylinders, the threaded hose connection is a standard size. Cylinders are rated according to breathing duration, which depends on the size and pressure of the cylinder. There are four standard sizes. United States Coast Guard regulations require an air supply sufficient for at least 10 minutes of normal breathing. The IMCO code for tank ships requires a cylinder capacity of 1,200 psi (42 feet) of air. This should be enough to provide breathing protection for about 30 minutes.
- **Backpack or sling pack.** The backpack or sling pack and the harness are designed to hold the unit securely and comfortably on the wearer. They differ slightly according to the manufacturer, but all makes are donned in about the same way. However, backpack units are donned and stowed differently from sling-pack units.

BACKPACK UNIT

11-177. The backpack unit is the most commonly used demand-type breathing apparatus. Its air supply has a longer duration than that of the sling-pack unit.

Donning

11-178. When a backpack unit has been properly stowed in its carrying case, it can be donned by the user without assistance (Figure 11-51). The unit should be stowed with the tank down, backpack up, and harness straps fully extended.

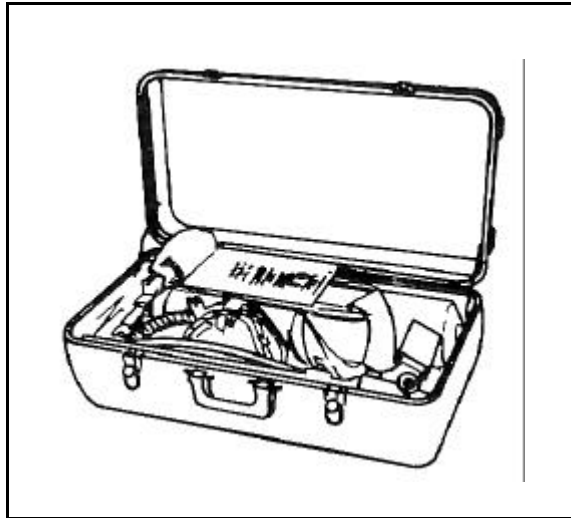

Figure 11-51. A Properly Stored Backpack Unit

11-179. The high-pressure air hose should be lying along the front of the case, with the regulator at the front right-hand corner. The harness take-up straps must be attached to the chest straps. One should be to the left of the regulator, and the other should be attached to the metal buckle on the right chest strap. The waist straps should be rolled or folded neatly between the backpack and the cylinder valve. The facepiece should be placed between the air cylinder and the high-pressure air hose.

11-180. When the unit has been stowed as described, it is donned in this way:

- **Step 1.** Take a crouched position at the right end of the open case. With one hand, grasp the cylinder valve handle and stand the cylinder and backpack on end. Check that the mainline valve (usually a yellow knob) is opened and locked in the open position. Check that the bypass valve (a red knob) is closed (Figure 11-52).
- **Step 2.** Check the cylinder gauge to be sure the cylinder is full. Then open the cylinder valve three turns. Now check the regulator gauge; it should read within 200 psi of the cylinder gauge. If the difference is more than 200 psi, assume the lower reading is correct. At the first opportunity, check the gauges for accuracy and make any necessary repairs (Figure 11-53).

- **Step 3.** Grasp the backpack with one hand on either side, making certain that the harness straps are resting on the backs of your hands or arms. From the crouched position, lift the unit over your head. Allow the harness to drop into position over your arms (Figure 11-54).
- **Step 4.** After the harness has cleared your arms, lean forward, still in the crouched position. Lower the unit to your back. While still in this position, fasten the chest buckle (Figure 11-55).
- **Step 5.** Stand, but lean slightly forward to balance the cylinder on your back. Then grasp the two underarm adjusting strap tabs. Pull the tabs downward to adjust the straps (Figure 11-56, page 11-68). To get the equipment as high on your back as possible, bounce the cylinder by moving your back and legs; at the same time, pull the tabs to position the cylinder.
- **Step 6.** Locate both ends of the waist harness, hook the buckle, and tighten the strap. Once this is done, the equipment is secure and you may stand erect.
- **Step 7.** Remove the facepiece from the case, and don it as described earlier. The donning of the facepiece should be practiced and mastered before this equipment is used.
- **Step 8.** Insert the quick connect coupling of the inhalation tube at the regulator, and tighten it down (Figure 11-57, page 11-68). To conserve air, this step should be performed just before you enter the contaminated area.



Figure 11-52. Donning the Backpack Unit,
Unit,
Step 1



Figure 11-53. Donning the Backpack
Step 2

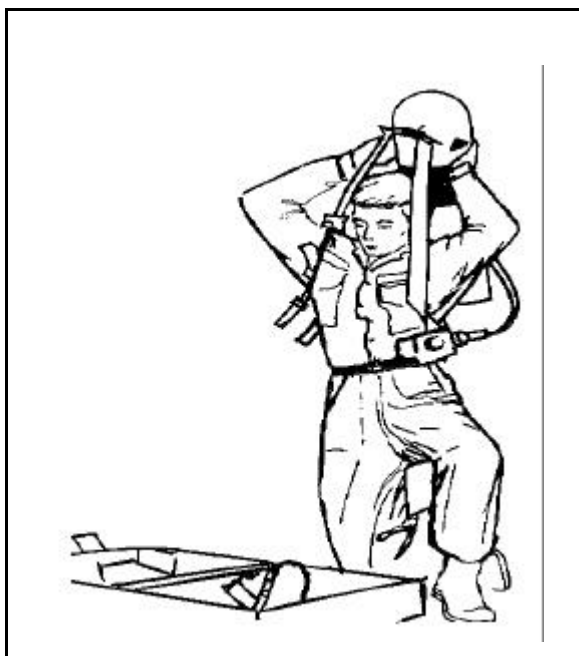

Figure 11-54. Donning the Backpack Unit, Unit, Step 3



Figure 11-55. Donning the Backpack Unit, Step 4



Figure 11-56. Donning the Backpack Unit, Step 5

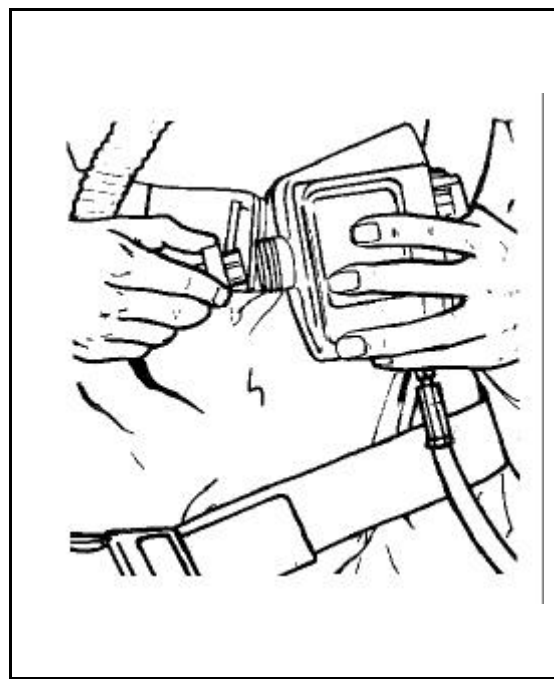

Figure 11-57. Donning the Backpack Unit, Step 8

Removal and Restowing

11-181. Remove the backpack unit as follows:

- **Step 1.** Disconnect the inhalation tube from the regulator.
- **Step 2.** With the tips of your fingers, release the self-locking buckles on the facepiece harness (2A). Remove the facepiece as described earlier (2B) (Figure 11-58).
- **Step 3.** Make sure the facepiece harness straps are fully extended. Pull the harness over the front of the facepiece and place the facepiece in the carrying case.
- **Step 4.** Unbuckle the backpack waist belt, and extend the belt fully.
- **Step 5.** With your thumb and index finger, release and hold the underarm strap buckles and extend them fully.
- **Step 6.** Disconnect the chest buckle.
- **Step 7.** With your left hand, get a firm grip on the body harness and the regulator at the point where they are attached. Slip your right arm out of the harness as if you were removing a vest (Figure 11-59).

- **Step 8.** Grasp the harness with your right hand, above and as close to the regulator as possible. Then remove the equipment from your left shoulder and arm (Figure 11-60, page 11-70). By removing the equipment this way, you will keep the regulator from striking nearby objects, which could damage it.
- **Step 9.** Close the valve on the air cylinder. Remove the air pressure from the regulator by cracking the bypass valve open momentarily.

The unit should be thoroughly cleaned, and the air cylinder should be replaced immediately with a full cylinder. However, it may be necessary to restow the equipment before it is cleaned and its cylinder is replaced. It should then be stowed in its case as described above. The case should be marked or tagged "Empty Cylinder. "

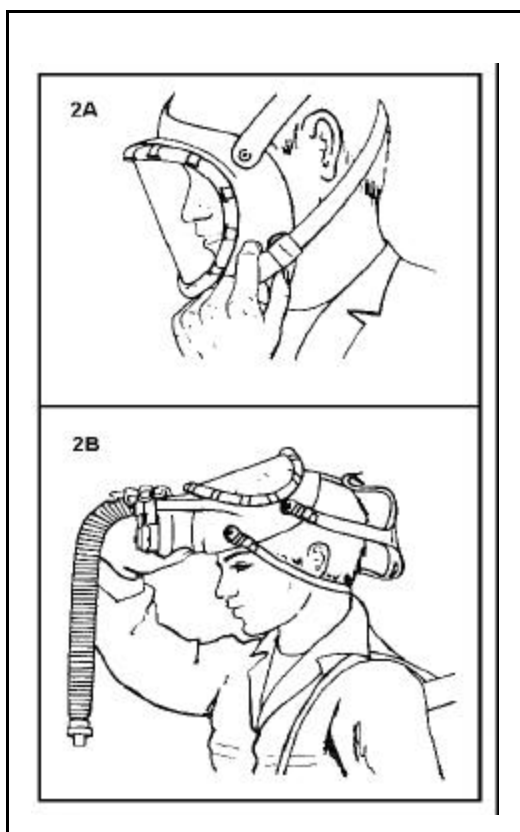

Figure 11-58. Removing and Restowing the Backpack Unit, Step 2

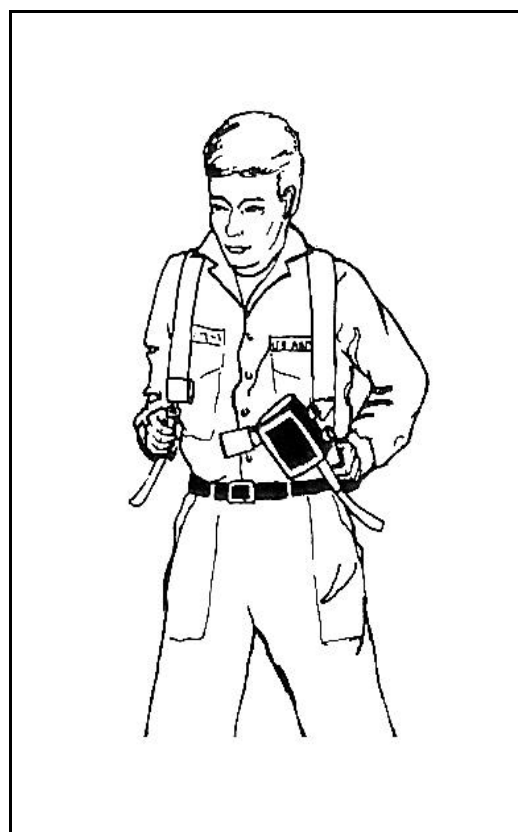

Figure 11-59. Removing and Restowing the Backpack Unit, Step 7



Figure 11-60. Removing and Restowing the Backpack Unit, Step 8

SLING-PACK UNIT

11-182. The sling-pack unit is generally stowed in a case. However, it is donned as follows no matter how it has been stowed:

- **Step 1.** Lay the facepiece aside, in a clean, dry place.
- **Step 2.** Grasp the shoulder strap with your right hand. The air cylinder should be to your left, and the regulator to your right.
- **Step 3.** In one motion, swing the unit onto your back while putting your left arm through the harness. Carry the shoulder strap over your head, and place it on your right shoulder (Figure 11-61).
- **Step 4.** Pull the strap to take up the slack (Figure 11-62).
- **Step 5.** Clip the waist straps together; tighten them by pulling the strap end to your right (Figure 11-63).
- **Step 6.** Don the facepiece as described previously.

Remove the sling-pack unit by reversing these steps. Clean the unit and replace the cylinder before the unit is stowed.

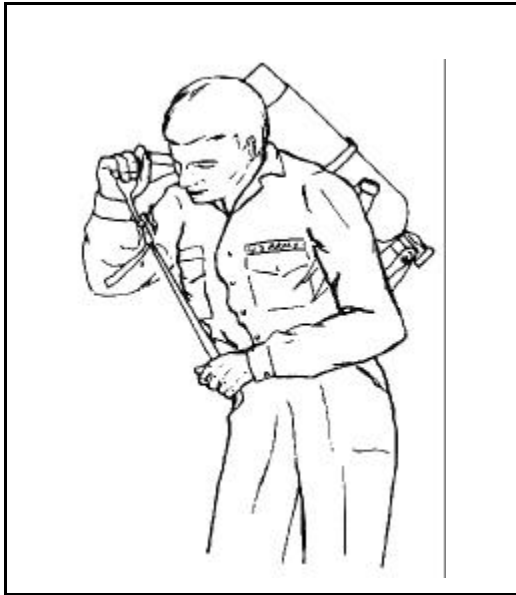

Figure 11-61. Donning the Sling-Pack Unit, Step 3



Figure 11-62. Donning the Sling-Pack Unit, Step 4



Figure 11-63. Donning the Sling-Pack Unit, Step 5